

INSTALLER MANUAL

AUTOTROL
PERFORMA UF 269
LOGIX 869



RESIDENTIAL

Table of Contents

1	Generalities	6
1.1	Scope of the documentation	6
1.2	Release management	6
1.3	Manufacturer identifier, product	6
1.4	Abbreviations used	7
1.5	Norms	7
1.5.1	Applicable norms	7
1.5.2	Available certificates	8
1.6	Procedure for technical support.....	8
1.7	Copyright and Trademarks	8
1.8	Limitation of liability.....	8
2	Safety	9
2.1	Safety pictograms definition	9
2.2	Serial label location.....	10
2.3	Hazards.....	10
2.3.1	Personnel	10
2.3.2	Material	10
2.4	Hygiene and sanitization	11
2.4.1	Sanitary issues	11
2.4.2	Hygiene measures.....	11
3	Description	12
3.1	Technical specifications	12
3.2	Performance flow rate characteristics.....	13
3.3	Outline drawing	13
3.4	Components description and location	14
3.5	Options available on the valve	15
3.5.1	Chlorine generator (check salt light)(If present).....	15
3.5.2	Valve Camshaft (Green).....	17
3.5.3	Blending valve kit	19
3.6	System regeneration cycle.....	20
4	System sizing.....	23
4.1	Recommended Injector/DLFC/BLFC-Valve configuration	23
4.2	Cycle time calculation	23
4.3	Salt amount definition	23
4.4	Injector flow rates	24
5	Installation	25

5.1	Safety notices for installation	25
5.2	Installation environment	25
5.2.1	General	25
5.2.2	Water	25
5.2.3	Electrical	25
5.2.4	Mechanical	26
5.2.5	Outdoor Locations	26
5.3	Integration constraints.....	27
5.4	Block diagram and configuration example.....	29
5.5	Valve connection to piping.....	30
5.5.1	Top-mounted valve installation	30
5.6	Electrical connections.....	32
5.7	Bypassing	32
5.8	Drain line connection	33
5.9	Overflow line connection.....	34
5.10	Brine line connection	35
6	Programming	36
6.1	Display	36
6.2	Commands	37
6.3	Basic programming.....	38
6.3.1	Basic programming mode chart.....	38
6.3.2	Model number selection	39
6.3.3	Time setting.....	39
6.3.4	Day of week	39
6.3.5	Regeneration time.....	40
6.3.6	Hardness	40
6.4	Advanced programming.....	41
6.4.1	Advanced programming mode chart	41
6.4.2	Chlorine generator	42
6.4.3	Service interval.....	42
6.4.4	Calendar override.....	43
6.4.5	Remote regeneration switch close time.....	43
6.4.6	Manual regeneration options.....	43
6.4.7	Salt amount	44
6.4.8	Capacity	44
6.4.9	Language	45
6.4.10	Reserve type.....	45
6.4.11	Reserve percent	46
6.4.12	Clock mode.....	46
6.4.13	Units of measure	46
6.4.14	Refill controller	47
6.4.15	Injector	47
6.4.16	Slow rinse.....	48
6.4.17	Backwash	48

6.4.18	Fast rinse.....	49
6.4.19	Historic	49
6.4.20	Resetting the controller	50
7	Commissioning	51
7.1	Water filling, draining and waterproofness inspection	51
7.1.1	Activating the softener	51
7.1.2	Additional tips.....	52
7.2	Sanitization	53
7.2.1	Disinfection of water softeners.....	53
7.2.2	Sodium or calcium hypochlorite	53
7.2.3	Electro chlorination (if present).....	54
8	Operation.....	55
8.1	Recommendations	55
8.2	Manual regeneration.....	55
8.3	To advance regeneration cycles.....	55
8.4	To cancel a regeneration	56
9	Maintenance	57
9.1	General system inspection.....	57
9.1.1	Water quality	57
9.1.2	Mechanical Checks	57
9.1.3	Regeneration test.....	57
9.2	Recommended maintenance plan	58
9.3	Recommendations	59
9.3.1	Use original spare parts.....	59
9.3.2	Use original approved lubricants.....	59
9.3.3	Maintenance instructions	59
9.4	Cleaning and maintenance.....	60
9.4.1	First steps.....	60
9.4.2	Injector cleaning.....	60
9.4.3	Refill controller cleaning	60
9.4.4	Injector screen cleaning	62
9.4.5	Backwash controller cleaning	62
9.4.6	Valve cover disassembly	63
9.4.7	Motor and camshaft replacement	64
9.4.8	Optical sensor and controller replacement	65
9.4.9	Turbine cleaning or replacement	66
9.4.10	Top plate, flapper spring and flappers replacement.....	67
9.4.11	Valve on tank assembly.....	69
10	Troubleshooting	70
10.1	Logix controller	70
10.2	Performa Valve.....	71
11	Spare parts.....	74

11.1	Valve parts list.....	74
11.2	869 Controller.....	76
11.3	1265 Bypass & Connections.....	77
11.4	Valve installation kits	78
12	Disposal.....	80

1 Generalities

1.1 Scope of the documentation

The documentation provides the necessary information for appropriate use of the product. It informs the user to ensure efficient execution of the installation, operation or maintenance procedures.

The content of this document is based on the information available at the time of publication. The original version of the document was written in English.

For safety and environmental protection reasons, the safety instructions given in this documentation must be strictly followed.

This manual is a reference and will not include every system installation situation. The person installing this equipment should have:

- training in the Autotrol series, Logix 869 controllers and water softener installation;
- knowledge of water conditioning and how to determine proper controller settings;
- basic plumbing skills.

This document is available in other languages on <https://www.pentair.eu/product-finder/product-type/control-valves>.

1.2 Release management

Revision	Date	Authors	Description
A	19.10.2022	BRY/FLA	First edition.

1.3 Manufacturer identifier, product

Manufacturer: Pentair International LLC
Avenue de Sevelin 18
1004 Lausanne
Switzerland

Product: Autotrol Performa UF 269 Logix 869

1.4 Abbreviations used

Assy	Assembly
BLFC	Brine Line Flow Controller
DF	Down Flow
DLFC	Drain Line Flow Controller
HW	Hot Water
Inj	Injector
Regen	Regeneration
SBV	Safety Brine Valve
STD	Standard
TC	Time Clock
UF	Up Flow

1.5 Norms

1.5.1 Applicable norms

Comply with the following guidelines:

- 2006/42/EC: Machinery Directive;
- 2014/35/UE: Low Voltage Directive;
- 2014/30/UE: Electromagnetic compatibility;
- 2011/65/UE: Restriction of use of certain hazardous substances in electrical and electronic equipment (RoHS);
- UNI EN ISO9001.

Meets the following technical standards:

- IEC/EN 60335-1;
- IEC 61010-1;
- EN 55014-1;
- EN 55014-2;
- EN 61000-3-2: 2006 + A1: 2009 + A2: 2009;
- EN 61000-3-3: 2008;
- EN 61000-6-2: 2005;
- EN 61000-6-3: 2007 + A1: 2011;
- EN 61326-1.

1.5.2 Available certificates

- CE;
 - DM174;
 - ACS.
- Please find beside the certifications for some of our product families. Please note that this list is not an exhaustive list of all our certifications. In case of need for more information please contact us.



1.6 Procedure for technical support

Procedure to follow for any technical support request:

1. Collect the required information for a technical assistance request.
 - ⇒ Product identification [see Serial label location [→Page 10] and Recommendations [→Page 59]];
 - ⇒ Description of the device problem.
2. Please refer to the Troubleshooting [→Page 70]. If the problem persists contact your supplier.

1.7 Copyright and Trademarks

All indicated Pentair trademarks and logos are property of Pentair. Third party registered and unregistered trademarks and logos are the property of their respective owners.

© 2022 Pentair. All rights reserved.

1.8 Limitation of liability

Pentair Quality System EMEA products benefit, under specific conditions, from a manufacturer warranty that may be invoked by Pentair's direct customers. Users should contact the vendor of this product for applicable conditions and in case of a potential warranty claim.

Any warranty provided by Pentair regarding the product will become invalid in case of:

- installation done by a non-water-professional;
- improper installation, improper programming, improper use, improper operation and/or maintenance leading to any kind of product damages;
- improper or unauthorized intervention on the controller or components;
- incorrect, improper or wrong connection/assembly of systems or products with this product and vice versa;
- use of a non-compatible lubricant, grease or chemicals of any type and not listed by the manufacturer as compatible for the product;
- failure due to wrong configuration and/or sizing.

Pentair accepts no liability for equipment installed by the user upstream or downstream of Pentair products, as well as for process/production processes which are installed and connected around or even related to the installation. Disturbances, failures, direct or indirect damages that are caused by such equipment or processes are also excluded from the warranty. Pentair shall not accept any liability for any loss or damage to profits, revenues, use, production, or contracts, or for any indirect, special or consequential loss or damage whatsoever. Please refer to the Pentair List Price for more information about terms and conditions applicable to this product.

2 Safety

2.1 Safety pictograms definition

DANGER



This combination of symbol and keyword indicates an imminently hazardous situation that will result in serious or fatal injury if not avoided.

WARNING



This combination of symbol and keyword indicates a potentially hazardous situation that can result in serious or fatal injury if not avoided.

CAUTION



This combination of symbol and keyword indicates a potentially hazardous situation that can result in minimal or minor injury if not avoided.

Caution - material



This combination of symbol and keyword indicates a potentially hazardous situation that can result in material damage if not avoided.

Prohibition



Mandatory advice to follow.

Mandatory



Applicable guideline, measure.

Info



Informative comment.

2.2 Serial label location

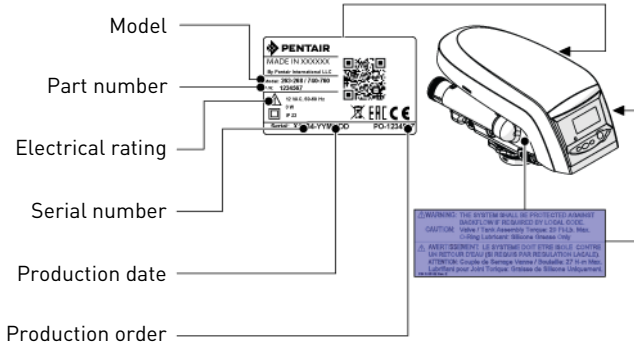

Mandatory

! Ensure that the serial label and the safety labels on the device are completely legible and clean !

If necessary, replace them with new labels in the same positions.

2.3 Hazards

All the safety and protection instructions contained in this document must be observed in order to avoid temporary or permanent injury, damage to property or environmental pollution.

At the same time, any other legal regulations, accident prevention and environmental protection measures, as well as any recognized technical regulations relating to appropriate and risk-free methods of working which apply in the country and place of use of the device must be adhered to.

Any non-observation of the safety and protection rules, as well as any existing legal and technical regulations, will result in a risk of temporary or permanent injury, damage to property or environmental pollution.

2.3.1 Personnel

! CAUTION

! Risk of injury due to improper handling!

Only qualified and professional personnel, based on their training, experience and instruction as well as their knowledge of the regulations, safety rules and operations performed, are authorized to carry out necessary work.

2.3.2 Material

The following points must be observed to ensure proper operation of the system and the safety of user:

- be careful of high voltages present on the transformer (100 – 240 V);
- do not put your fingers in the system (risk of injuries with moving parts and shock due to electric voltage).

2.4 Hygiene and sanitization

2.4.1 Sanitary issues

Preliminary checks and storage

- Check the integrity of the packaging. Check that there is no damage and no signs of contact with liquid to make sure that no external contamination occurred;
- the packaging has a protective function and must be removed just before installation. For transportation and storage, appropriate measures should be adopted to prevent the contamination of materials or the objects themselves.

Assembly

- Assemble only with components which are in accordance with drinking water standards;
- after installation and before use, perform one or more manual regenerations in order to clean the media bed. During such operations, do not use the water for human consumption. Perform a disinfection of the system in the case of installations for treatment of drinking water for human use.

Info



This operation must be repeated in the case of ordinary and extraordinary maintenance.

It should also be repeated whenever the system remains idle for a significant time.

Info



Valid only for Italy

In case of equipment used in accordance with the DM25, apply all the signs and obligations arising from the DM25.

2.4.2 Hygiene measures

Disinfection

- The materials used for the construction of our products meet the standards for use with potable water; the manufacturing processes are also geared to preserving these criteria. However, the process of production, distribution, assembly and installation, may create conditions of bacterial proliferation, which may lead to odor problems and water contamination;
- it is therefore strongly recommended to sanitize the products. See Sanitization [[->Page 53](#)];
- maximum cleanliness is recommended during the assembly and installation;
- for disinfection, use Sodium or Calcium Hypochlorite and perform a manual regeneration.

3 Description

3.1 Technical specifications

Design specifications/ratings

Valve body	Glass-filled Noryl [®] - NSF listed material
Rubber components	Compounded for cold water - NSF listed material
Valve material certification	WQA Gold Seal Certified to ORD 0902, NSF/ANSI 44, CE, ACS
Weight (valve with controller)	2.42 kg
Recommended operating pressure	1.4 - 8.3 bar
Hydrostatic test pressure	20.69 bar
Water temperature	1 - 38°C
Ambient temperature*	2 - 50°C

Flow rates (valve only)

Service at 1.03 bar drop	5.7 m ³ /h
Backwash at 1.72 bar drop	4.5 m ³ /h
Service	Kv = 5.6 m ³ /h (Cv = 6.50 gpm)
Backwash	Kv = 3.5 m ³ /h (Cv = 4.00 gpm)

Valve connections

Tank Thread	2½" - 8 NPSM, male
Inlet/Outlet Thread	1¾" 12 UNC - 2A male
Drain line	¾" NPT, male
Brine line	¾" NPT, male
Distributor tube [Ø]	27 mm [1.05"]
Distributor tube length	13 mm ± 3 mm [½ ± ⅛"] above top of tank

Electrical

Controller Operating Voltage	12 VAC (requires use of Pentair Water supplied transformer)
Input Supply Frequency	50 or 60 Hz (controller configuration dependent)
Motor Input Voltage	12 VAC
Controller Power Consumption	3 W average
Protection rating	IP23

3.2 Performance flow rate characteristics

The graph shows the pressure drop created by the valve itself at different flow rates. It allows predetermining the maximum flow rate going through the valve depending on the system settings (inlet pressure etc). It also allows to determine the valve pressure drop at a given flow rate, and therefore to evaluate the system pressure drop vs flow rate.

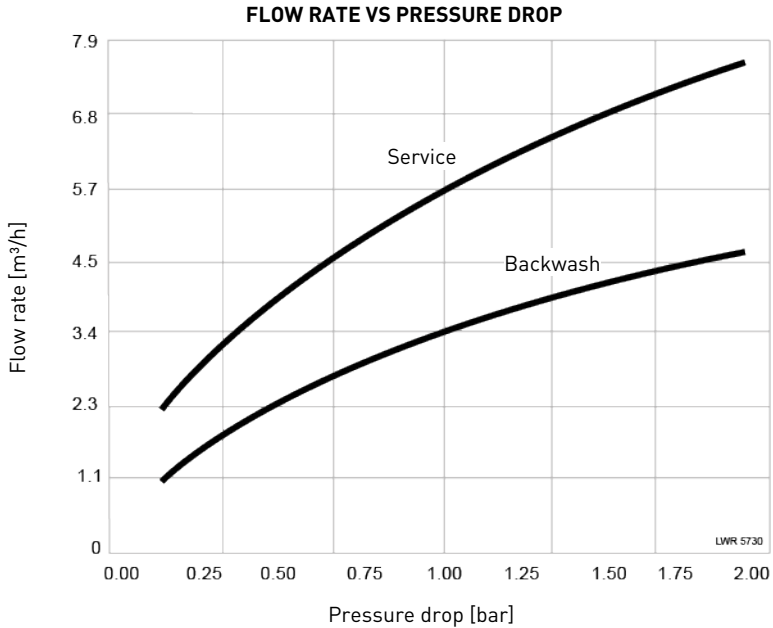

3.3 Outline drawing

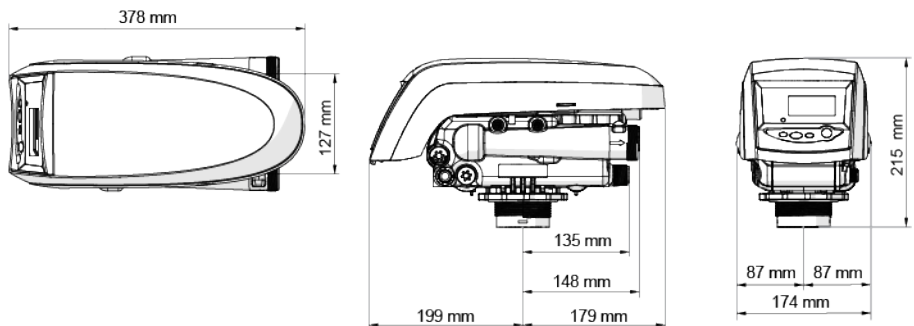

3.4 Components description and location

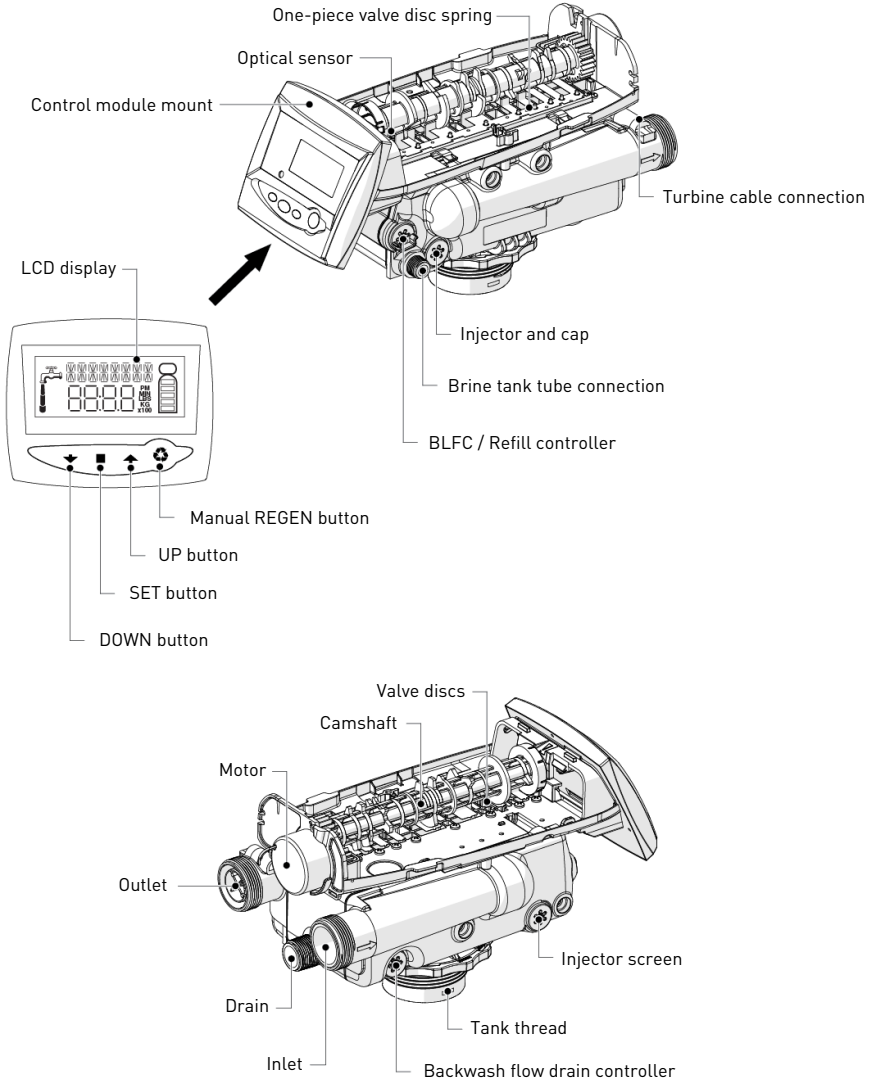

3.5 Options available on the valve

3.5.1 Chlorine generator (check salt light)(If present)

Info



The chlorine generator is not sold anymore from 1.11.2022 due to directive EN528-2012.

The Logix 740 and 760 controllers have the capability to produce a low level of chlorine to chlorinate the resin bed during regeneration. A check salt light will indicate when the user needs to add salt to the brine tank. Potassium chloride or sodium chloride may be used.

1. Unplug the wall-mounted transformer.
2. Shut off water supply or put bypass valve(s) into bypass position.
3. Relieve system pressure before performing any operations.
4. Unlock the cover (2) from the slide clips (1) (one on each side of the valve).
5. Remove the controller (3) by pressing on (4).
6. Connect the small chlorine generator connector to the back of the controller (5).
7. Remove the existing refill controller (6) with the ball (7) and replace them by the chlorinator.
8. Plug, firmly to ensure a good contact, the connector in the chlorinator and connect the end of the cable to the refill controller previously installed.
9. Reverse above procedure steps to rebuild.

Info



Note

No programming is necessary for the chlorine generator to work properly on the controller. The system will be automatically functional after the chlorine generation senses brine for the first time. There is a check salt light on the front of the controller that will illuminate when there is no brine present during the brine draw.

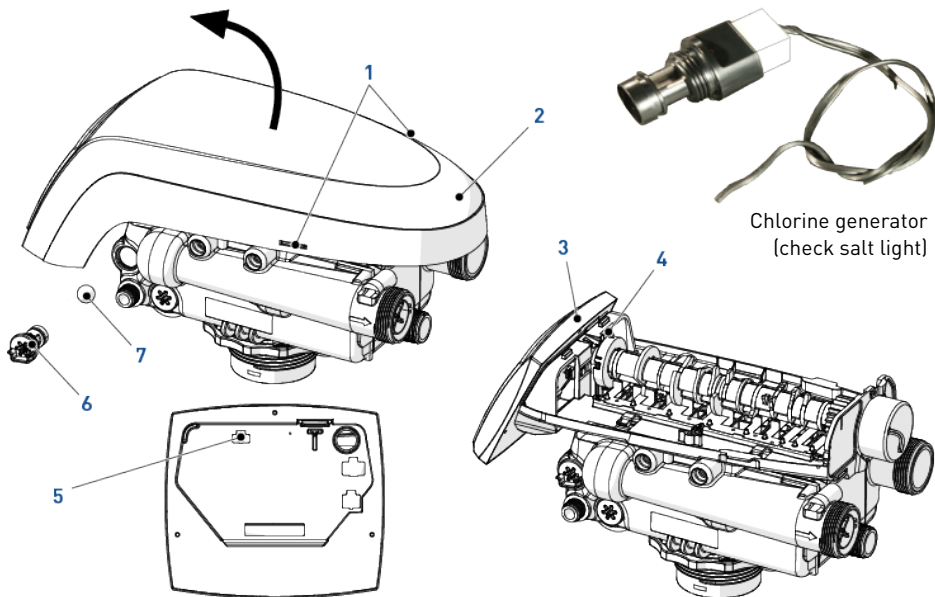

3.5.2 Valve Camshaft (Green)

The front end of the camshaft has an indicator cup. The cup has slots in the outer periphery and numbers on the inside face.

The numbers can be seen with the cover off, from the front over the top of the controller. The number at the top indicates which regeneration cycle is currently in progress.

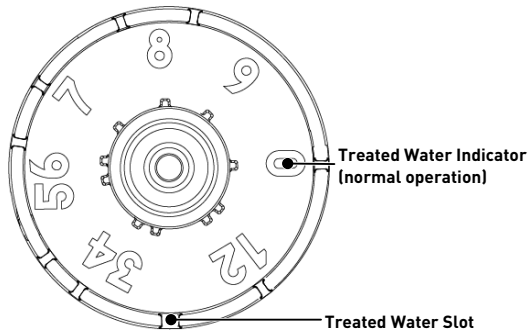

The corresponding slot for the number is positioned at the optical sensor which is approximately 90 degrees out of phase.

Regeneration Cycle Indicators

- 0 Treated Water - normal operation mode
- 1 Brine Refill
- 2 Brine Prep
- 3 Brine Draw / Slow Rinse Cycle
- 4* Holiday
- 5* Brine Empty / Slow Rinse
- 6 System Pause
- 7 System Pause
- 8 Backwash Cycle
- 9 Fast Rinse Cycle

*Cycles are skipped unless "Holiday Mode" is enabled.

Valve Disc Operation

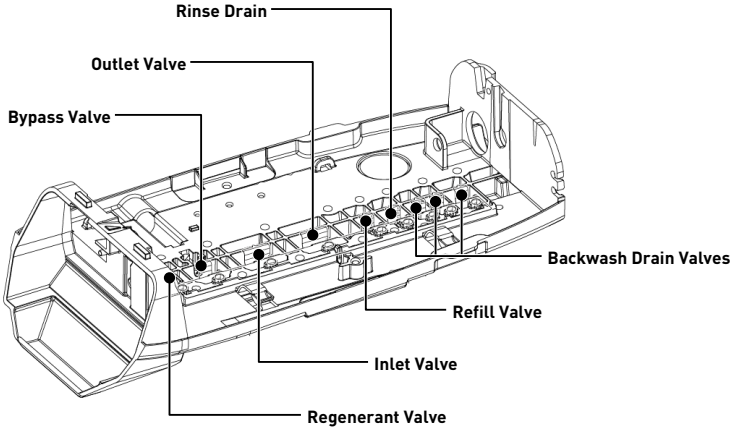

3.5.3 Blending valve kit

Tightening the adjusting screw provided by the kit will force the bypass flapper open. The open flapper will allow untreated (hard) water to blend with the treated water supply. As the adjusting screw is turned in, the hardness of the outlet water increases.

Loosening the adjusting screw will allow the bypass flapper to close. The closing action will blend less untreated water into the outlet flow.

To blend a specific amount of hardness into outflow, adjust the screw and test the water. Repeat the following procedure as needed until the desired hardness level is reached.

1. Insert the nut (3) into the blending valve orifice (2).
2. Insert the adjusting screw (4) through the top plate and then through the nut.
3. Tighten the adjusting screw (4) until it touches the bypass flapper (1).
4. Adjust the position of the screw (4) until the desired hardness level of water is reached.

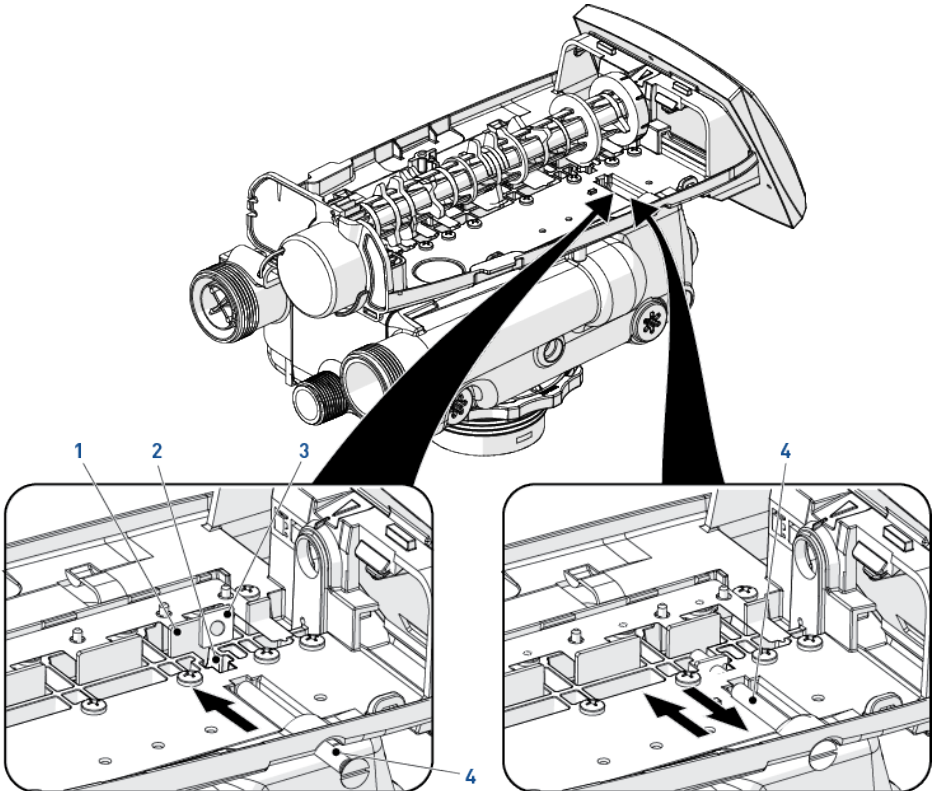

3.6 System regeneration cycle

Service (downflow) — Cycle C0

Untreated water is directed down through the resin bed and up through the riser tube. The hardness ions attach themselves to the resin and are removed from the raw water being exchanged on the resin beads against sodium ions. The water is conditioned as it passes through the resin bed.

Proportional brine refill — cycle C1

Water is directed to the brine tank at a rate controlled by the refill controller, to create brine for the next regeneration. During brine refill, treated water is already available at the valve outlet.

Brine Preparation – cycle C2

The refill water is allowed to dissolve the salt and prepare brine.

Brine/Slow Rinse (Upflow) – cycle C3

Water is directed through the brine injector and brine is drawn from the regenerant tank. The brine is then directed down the riser tube up through the resin bed and up to the drain. The hardness ions are displaced by sodium ions and are sent to the drain. The resin is regenerated during the brine cycle. Brine draw is completed when the air check closes.

Repressurize cycle (hard water bypass flapper open) — cycle C4

This cycle allows the air and water to hydraulically balance in the valve before continuing the regeneration.

Backwash (Upflow) — cycle C5

The flow of water is reversed by the valve and directed down the riser tube and up through the resin bed. During the backwash cycle, the bed is expanded and debris are flushed to the drain, while the media bed is remixed.

Fast rinse (downflow) — cycle C6

The controller valve directs water down through the resin bed and up through the riser tube to the drain. Any residual brine is rinsed from the resin bed, while the media bed is re-compacted.

Info



For illustration purpose only. Always verify inlet and outlet marking on the valve.

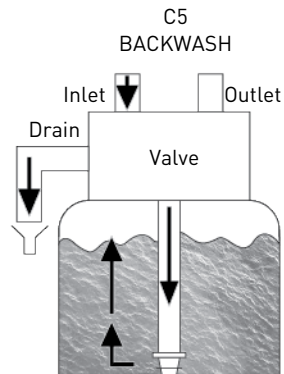
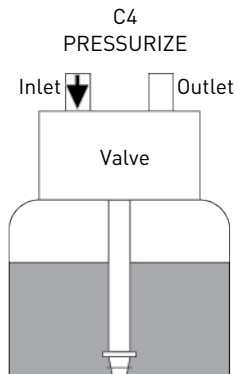
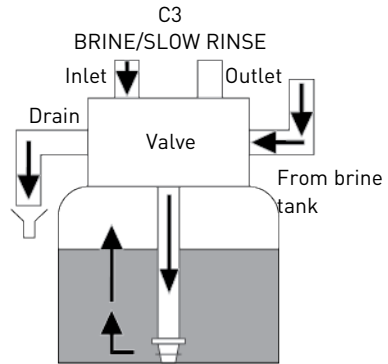
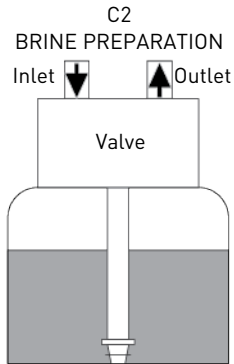
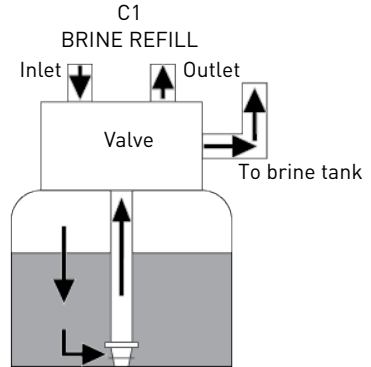
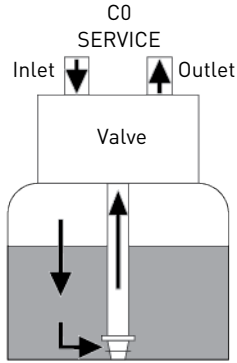

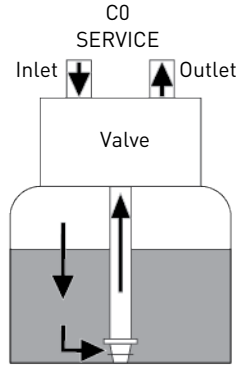
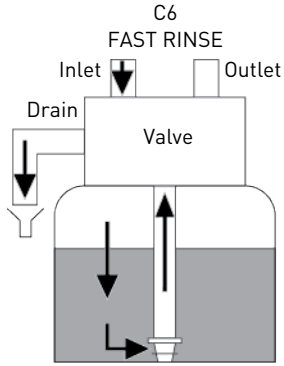

4 System sizing

4.1 Recommended Injector/DLFC/BLFC-Valve configuration

Vessel diameter [In]	Media volume [L]	Injector flow control	Refill flow control [gpm]	Backwash flow control [gpm]
7	15	5	0.33	1.2
8	20	5	0.33	1.6
9	25	5	0.33	2.0
9	30	5	0.33	2.5
10	35	5	0.33	2.5
12	45	5	0.33	2.5
13	50	8	0.33	3.5
14	60	8	0.33	3.5
14	65	8	0.33	4.1
14	70	8	0.33	4.1
16	100	8	0.33	4.8

4.2 Cycle time calculation

All the Logix controller range automatically calculates the unit capacity as well as the cycle time. No calculations are therefore required.

4.3 Salt amount definition

The salt amount is set in kilograms of salt use for each regeneration. This setting will greatly influence the system. Make sure this setting is aligned with your actual system size and unit programmed.

Salt amount [g/Lresin]	Corresponding Resin Exchange Capacity [g/Lresin as CaCO ₃]	°f/m ³	°d/m ³
50	29.9	2.99	1.67
60	34.0	3.40	1.90
70	37.5	3.75	2.09
80	40.6	4.06	2.27
90	43.4	4.34	2.42
100	45.9	4.59	2.56
110	48.2	4.82	2.69
120	50.2	5.02	2.80
130	52.1	5.21	2.91
140	53.8	5.38	3.01

Salt amount [g/Lresin]	Corresponding Resin Exchange Capacity [g/Lresin as CaCO3]	°f/m ³	°d/m ³
150	55.5	5.55	3.10
170	58.5	5.85	3.27
200	62.7	6.27	3.50
230	66.9	6.69	3.74
260	71.0	7.10	3.97
290	75.3	7.53	4.21

4.4 Injector flow rates

The following table represents the injectors flow rate at the inlet pressure of 2.4 bar.

Injector flow control	Flow [Lpm]
5	0.49
8	0.75

5 Installation

5.1 Safety notices for installation

- Observe all warnings that appear in this manual;
- only qualified and professional personnel are authorized to carry out installation work.

5.2 Installation environment

5.2.1 General

- Use only brine salts designed for water softening. Do not use ice melt, block, or rock salts;
- keep the media tank in an upright position. Do not turn on its side, upside down, or drop it. Turning the tank upside down may cause media to enter the valve or might clog the upper screen;
- follow State and local codes for water testing. Do not use water that is micro-biologically unsafe or of unknown quality;
- when filling the media tank with water, first place the valve in the backwash position, then partly open the valve. Fill the tank slowly to prevent media from exiting the tank;
- when installing the water connection (bypass or manifold), first connect to the plumbing system. Allow heated parts to cool and cemented parts to set before installing any plastic parts. Do not get primer or solvent on O-rings, nuts, or the valve.

5.2.2 Water

CAUTION



Do not treat water under 1°C or over 49°C, hot water would damage the softener and void warranty.

- If you are on a private well system, check minimum water pressure with an accurate gauge (gauges on older water systems are often inaccurate). Static pressure that is less than 2 bar may cause low flow rate and inadequate regeneration, depending by the pressure drop of the system as a minimum of 1.38 bar dynamic pressure (on injector at 1.2 m³/h) of water is required for the valve's injector to operate effectively;

Mandatory



Do not exceed a maximum of 8.6 bar inlet pressure. Should this happen or be subject to happen, it is necessary to install a pressure regulator upstream the system.

5.2.3 Electrical

There are no user-serviceable parts in the AC/AC or AC/DC transformer, motor, or controller. In the event of a failure, these should be replaced.

- All electrical connections must be completed according to local codes;
- use only the power AC/AC or AC/DC transformer that is supplied;

Mandatory



The use of any other power transformer than the one supplied void the warranty of all electronic parts of the valve!

- the power outlet must be grounded;
- to disconnect power, unplug the AC/AC or AC/DC transformer from its power source;
- an uninterrupted current supply is required. Please make sure that the voltage supply is compatible with the unit before installation;
- make sure the controller power source is plugged in;
- if the electrical cable is damaged, it is imperative that it is replaced by qualified personnel.

5.2.4 Mechanical

Caution - material



Risk of damage due to wrong lubricant use !

Do not use petroleum-based lubricants such as vaseline, oils, or hydrocarbon-based lubricants.

Use only approved silicone grease or soapy water !

- All plastic connections should be hand-tightened. PTFE (plumber's tape) may be used on connections that do not use an O-ring seal. Do not use pliers or pipe wrenches;
- existing plumbing should be in a good shape and free from limescale. In case of doubt, it is preferable to replace it;
- all plumbing must be completed according to local codes and installed without tension or bending stresses;
- soldering near the drain line should be done before connecting the drain line to the valve. Excessive heat will cause interior damage to the valve;
- do not use lead-based solder for sweat solder connections;
- the drain line may be elevated up to 1.8 m providing the run does not exceed 4.6 m and water pressure at the softener is not less than 2.76 bar. Elevation can increase by 61 cm for each additional 0.69 bar of water pressure at the drain connector; do not use lead-based solder for sweat solder connections;
- the drain line must be a minimum of 12.7 mm (1/2") in diameter. Use 19 mm (3/4") pipe if the backwash flow rate is greater than 26.5 lpm or the pipe length is greater than 6 m;
- do not support the weight of the system on the valve fittings, plumbing, or the bypass;
- it is not recommended to use sealants on the threads. Use PTFE (plumber's tape) on the threads of the drain elbow, and other NPT/BSP threads;
- the installation of a pre-filter is always recommended (100µ nominal);
- valve inlet/outlet must be connected to main piping via flexible.

5.2.5 Outdoor Locations

When the water softening system is installed outdoors, several points must be considered:

- moisture — The valve and Logix 869 controller are rated for NEMA 3 locations. Falling water should not affect performance. The system is not designed to withstand extreme humidity or water spray from below. Examples are: constant heavy mist, near corrosive environment, upwards spray from sprinkler;
- direct Sunlight — The materials used will fade or discolour over time in direct sunlight. The integrity of the materials will not degrade to cause system failures. If it is necessary to locate the softener in direct sunlight, a protective outdoor cover (P/N 1267811) over the valve and controller is necessary;
- temperature — Extreme hot or cold temperatures may cause damage to the valve or controller. Freezing temperatures will freeze the water in the valve. This will cause physical damage to the internal parts as well as the plumbing. High temperatures will affect the controller. The display may become unreadable but the controller should continue to function. When the temperature drops back into normal operating limits the display will return to normal. A protective cover (P/ N 1267811) should assist with high temperature applications;
- insects — The controller and valve have been designed to keep all but the smallest insects out of the critical areas. Any holes in the top plate can be covered with a metal foil ductwork tape. The top cover should be installed securely in place;
- wind — The Logix cover is designed to withstand a 48 km/h wind when properly installed on the valve.

5.3 Integration constraints

Location of a water treatment system is important. The following conditions are required:

CAUTION



The surface for installation (platform or floor) must be solid, flat and level.

Mandatory



Drain must be capable of handling a maximum backwash flow rate of 19 L/min.

- locate the softener as close as possible from drain discharge point and within 12.2 m maximum of drain discharge point, respecting minimum drain line diameter advises given at chapter Drain line connection [→Page 33];
- room to access equipment for maintenance and adding brine (salt) to tank;
- constant electrical supply to operate the controller;
- total minimum pipe run to water heater of 3 m to prevent backup of HW into system;
- always install check valve before water heater to protect the softener from HW return;
- local drain for discharge as close as possible;
- water line connections with shut off or bypass valves;
- must meet any local and state codes for site of installation;
- valve is designed for minor plumbing misalignments. Do not support weight of system on the plumbing;

- use flexible piping to connect main piping to softener;
- be sure all soldered pipes are fully cooled before attaching plastic valve to the plumbing.

5.4 Block diagram and configuration example

Block diagram

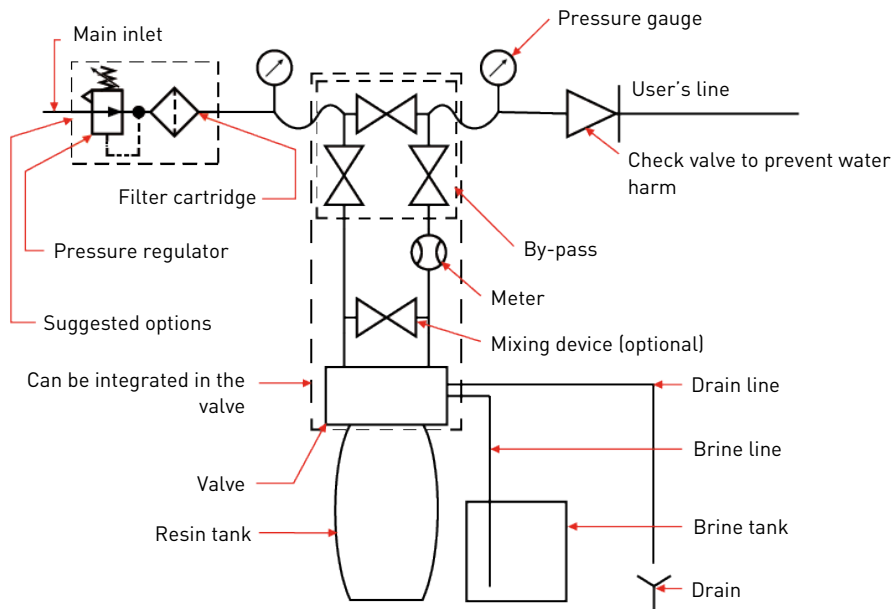

Configuration example:

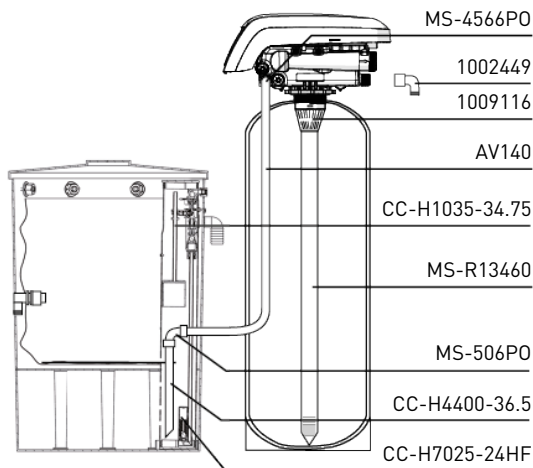

Correct drain line flow control must be fitted depending on media type and vessel size.

5.5 Valve connection to piping

The connections should be hand tightened using PTFE (plumber's tape) on the threads if using the threaded connection type.

In case of heat welding (metal type connection), the connections should not be made to the valve when soldering.

Tip



See chapter Components description and location [→Page 14] to identify the connections.

When pressurized, any composite tank will expand both vertically and circumferential. In order to compensate the vertical expansion, the piping connections to the valve must be flexible enough to avoid overstress on the valve and tank.

5.5.1 Top-mounted valve installation

The valve and tank should not be supporting any part of the piping weight. This is hence compulsory to have the piping fixed to a rigid structure (e.g. frame, skid, wall...) so that the weight of it is not applying any stress on the valve and tank.

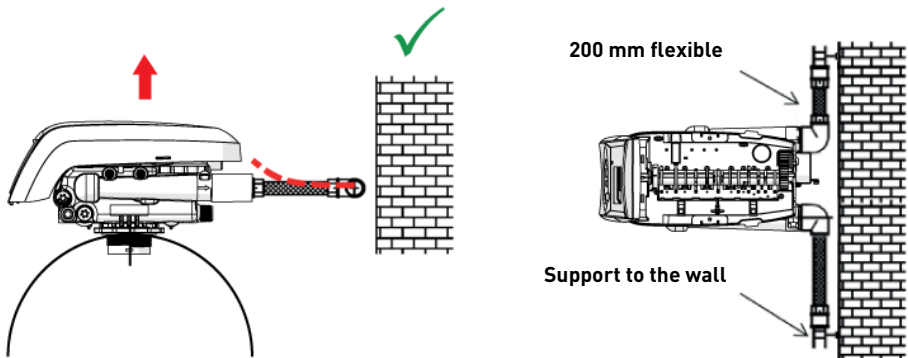

- The diagrams above illustrate how the flexible piping connection should be mounted;
- in order to adequately compensate the tank elongation the flexible tubes must be installed **horizontally**;
- should the flexible piping connection be installed in vertical position, instead of compensating the elongation, it will create additional stresses on the valve & tank assembly. Therefore this is to be avoided;
- the flexible piping connection must also be installed stretched, avoiding excessive length. For instance 20 – 40 cm is enough;
- excessively long and non-stretched flexible piping connection will create stresses on the valve and tank assembly when the system is pressurized, as illustrated in the below picture: on the left the assembly when the system is unpressurised, on the right the flexible piping connection when put under pressure tends to lift up the valve when stretching up. This configuration is even more dramatic when using semi-flexible piping;

- failure to provide enough vertical compensation may lead to different kinds of damage, either on the valve thread which is connected to the tank, or on the female thread connection of the tank. In some cases, damage may also be seen on the valve inlet and outlet connections;

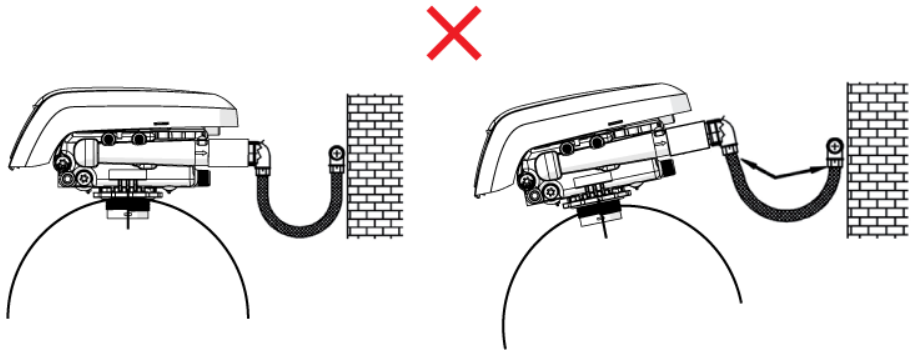

- in any case, any failure caused by improper installations and/or piping connections may void the warranty of Pentair products;
- in the same way, using lubricant* [→Page 31] on the valve thread is not allowed and will void the warranty for the valve and tank. Indeed using lubricant there will cause the valve to be over-torqued, which may lead to valve thread or tank thread damage even if the connection to piping has been done following the above procedure.

*Note: Use of petroleum-based grease and mineral based lubricant is totally forbidden, not only on the valve thread, since plastics used (especially Noryl) will highly suffer from contact with this type of grease, leading into structural damage hence to potential failures.

5.6 Electrical connections

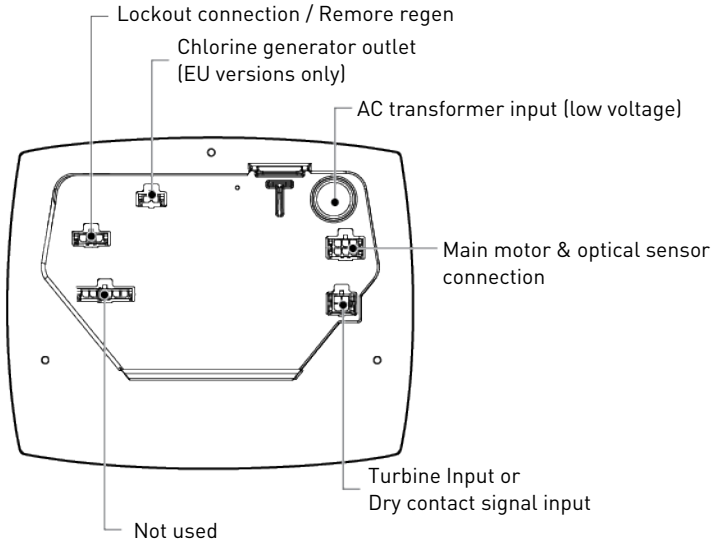

5.7 Bypassing

A bypass valve system should be installed on all water conditioning systems. Bypass valves isolate the softener from the water system and allow unconditioned water to be used. Service or routine maintenance procedures may also require that the system is bypassed.

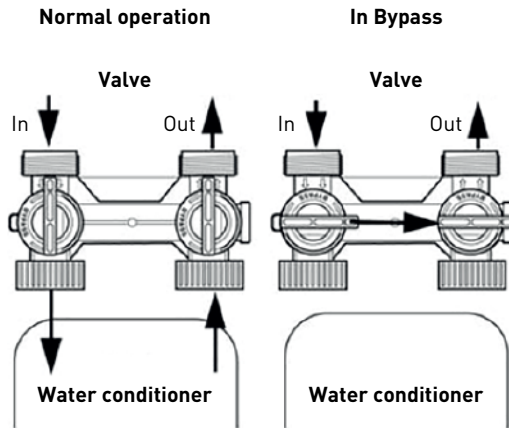

Caution - material

Risk of damage due to bad mounting!

Do not solder pipes with lead-based solder.

Do not use tools to tighten plastic fittings. Over time, stress may break the connections. When the bypass valve is used, only hand tighten the plastic nuts.

Do not use petroleum grease on gaskets when connecting bypass plumbing. Use only 100% silicone grease products when installing any plastic valve. Non-silicone grease may cause plastic components to fail over time.

5.8 Drain line connection

Info

Standard commercial practices are expressed here.

Local codes may require changes to the following suggestions.

Check with local authorities before installing a system.

Mandatory

The drain line must be build with 3/4" semi rigid or rigid piping ! An air gap must be present at the drain!
Caution - material

Risk of damage due to over-force !

The drain line plastic elbow must always be hand-tighten without using the elbow as a lever.

The drain plastic elbow is not designed to support the weight of the tube. The tube has to have its own support.

Do not over tighten the hose tightening ring on its plastic support.

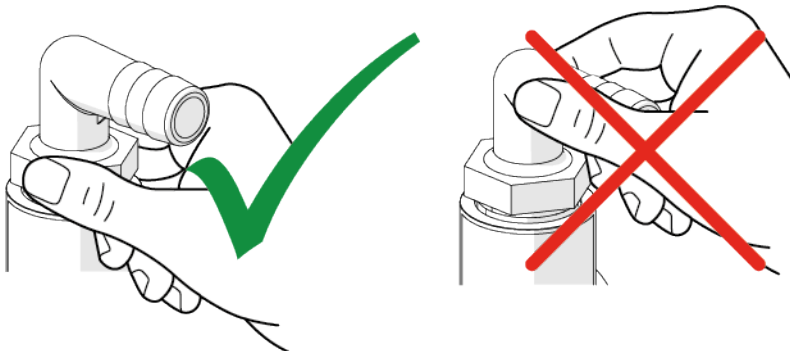

The unit should not be more than 6.1 m from the drain. Use an appropriate adapter fitting to connect 12.7 mm (1/2") plastic tubing to the drain line connection of the control valve.

If the backwash flow rate exceeds 22.7 Lpm or if the unit is located 6.1-12.2 m from the drain, use 19 mm (3/4") tubing. Use appropriate fittings to connect the 19 mm (3/4") tubing to the 19 mm (3/4") NPT drain connection on the valve.

The drain line may be elevated up to 1.8 m providing the run does not exceed 4.6 m and water pressure at the softener is not less than 2.76 bar. Elevation can increase by 61 cm for each additional 0.69 bar of water pressure at the drain connector.

Where the drain line is elevated but empties into a drain below the level of the valve, form a 18 cm loop at the far end of the line so that the bottom of the loop is level with the drain line connection. This will provide an adequate siphon trap.

Where the drain empties into an overhead sewer line, a sink-type trap must be used.

Secure the end of the drain line to prevent it from moving.

Mandatory



Waste connections or the drain outlet shall be designed and constructed to provide connection to the sanitary waste system through an air-gap of 2 pipe diameters or 25.4 mm (1"), whichever is larger.

Caution - material



Risk of damage due to lack of gap !

Never insert the drain line directly into a drain, sewer line or trap. Always allow an air gap between the drain line and the waste water to prevent the possibility of sewage being back-siphoned into the softener.

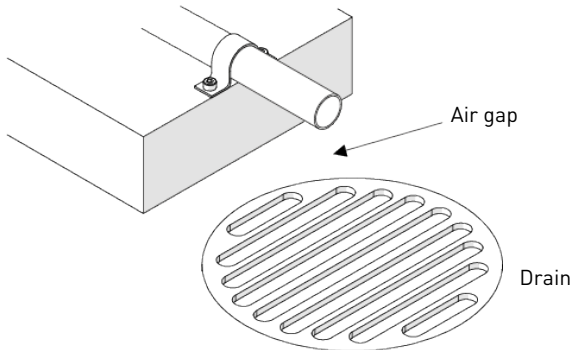

5.9 Overflow line connection

In the event of a malfunction, the brine tank overflow fitting will direct "overflow" to the drain instead of spilling on the floor. This fitting should be on the side of the brine tank. Most brine tank manufacturers feature a pre-drilled hole for the tank overflow connector.

To connect the overflow line, locate the hole on the side of the tank. Insert the overflow fitting into the tank and tighten with plastic thumb nut and gasket as shown below. Attach a 12.7 mm (1/2") I.D. tubing (not supplied) to fitting and run to drain.

Do not elevate overflow higher than overflow fitting.

Do not tie into the drain line of the controller unit. The overflow line must be a direct, separate line from overflow fitting to drain, sewer or tub. Allow an air gap as per drain line instructions.

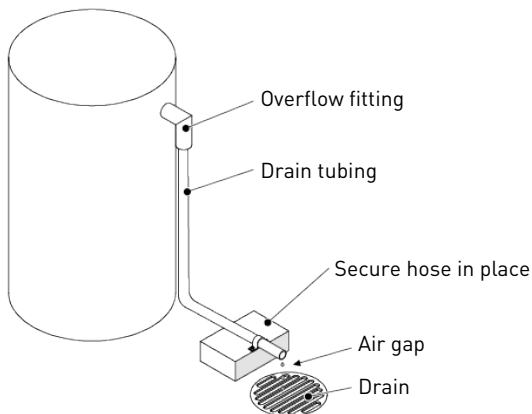

Caution - material



Risk of flooding due to lack of floor drain !

Floor drain is always recommended to avoid flooding in case of overflow.

5.10 Brine line connection

The brine line from the tank connects to the valve. Make the connections and hand tighten. Be sure that the brine line is secure and free from air leaks. Even a small leak may cause the brine line to drain out, and the conditioner will not draw brine from the tank. This may also introduce air into the valve, causing problems with the valve operation.

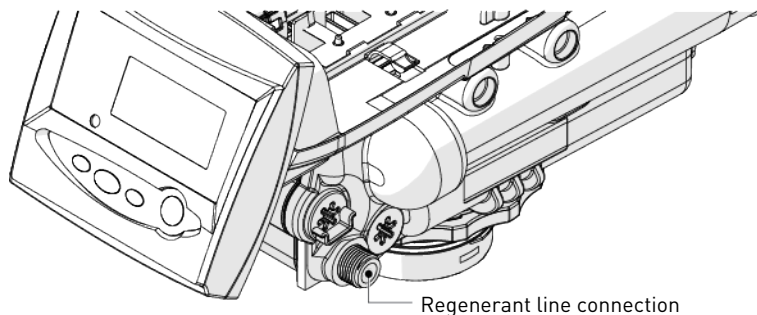

6 Programming

6.1 Display

Info



In normal operation and during programming, only a few of the icons will actually be displayed.

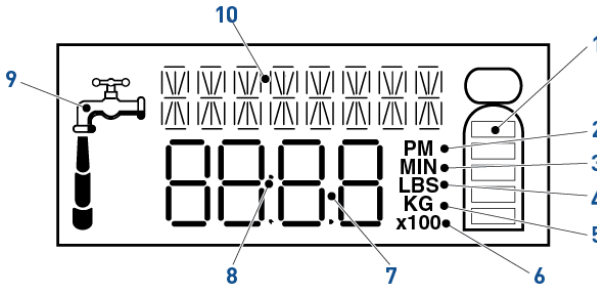





- | | | |
|-----|----------------|---|
| 1. | Tank | Displays amount of conditioning capacity remaining. |
| 2. | "PM" | Indicates that the time displayed is between 12:00 noon and 12:00 midnight.

"PM" indicator is not used if the clock mode is set to 24-hour (there is no AM indicator). |
| 3. | "MIN" | Indicates that the value entered/displayed is in minute increments. |
| 4. | "LBS" | Indicates that the value entered/displayed is in pounds. |
| 5. | "KG" | Indicates that the value entered/displayed is in kilograms or kilograins. |
| 6. | "x100" | x100 multiplier for large values. |
| 7. | Value display | Four digits used to display the time or program value. Also used for error codes. |
| 8. | Colon | Colon flashes as part of the time display.

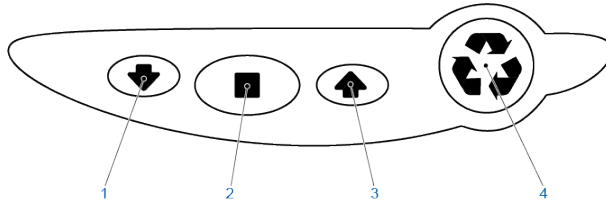
It also indicates normal operation. |
| 9. | Faucet | Shows when water is flowing through the valve. |
| 10. | Banner display | Eight digits used to display the parameter. |

6.2 Commands



- | | |
|---|---|
| <ol style="list-style-type: none"> 1.  - Down arrow 2.  - Set 3.  - Up arrow 4.  - Regenerate | <p>Used to scroll down or decrement through a group of choices.</p> <p>Used to accept a setting that normally becomes stored in memory.</p> <p>Also used together with the arrow buttons to access special features.</p> <p>Used to scroll up or increment through a group of choices.</p> <p>Used to command the controller to regenerate.</p> |
|---|---|

6.3 Basic programming

Info



Note







Menus are displayed in a defined and incremental order.

6.3.1 Basic programming mode chart

Parameter description	Range of values	Default value	Units of measure	Notes
Model number	1	1	N/A	The controller is pre-programmed to be used only with model number 1.
Time setting	1:00 - 12:59 AM 0:00 - 23:59 PM	12:00 PM	hour: minute	-
Day of week	SU = Sunday MO = Monday TU = Tuesday WE = Wednesday TH = Thursday FR = Friday SA = Saturday	None	N/A	-
Regeneration time	1:00 - 12:59 AM 0:00 - 23:59 PM	02:00 AM	hour: minute	-
Hardness	30 to 2000	300	mg/L equivalent CaCO ₃ or ppm	In increments of 10 ppm.

6.3.2 Model number selection







Set the model number at 1.

1. If necessary, press  when the model number is displayed.
⇒ Model number flashes.
2. Adjust model number to 1 with  and .
3. Press  to validate the selection and advance to the next parameter using  or .



6.3.3 Time setting







Set the current time.

1. Press  when the time of the day is displayed.
⇒ Time flashes.
2. Adjust displayed time with  and .
- ⇒ Default setting: 12:00 AM.
3. Press  to validate the selection and advance to the next parameter using  or .



6.3.4 Day of week





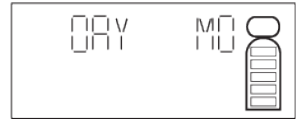

Set the current day of the week.

1. Press  when the day of week is displayed.
⇒ Day of week flashes.
2. Select displayed day with  and .
3. Press  to validate the selection and advance to the next parameter using  or .



6.3.5 Regeneration time





Set the time when regeneration will take place.

1. Press  when regeneration time is displayed.
⇒ Regeneration time flashes.
2. Adjust displayed time with  and .
3. Press  to validate the selection and advance to the next parameter using  or .



6.3.6 Hardness

Set inlet water hardness at installation site.

1. Press  when hardness is displayed.
⇒ The hardness number flashes.
2. Adjust hardness with  and .
3. Press  to validate the selection. Initial programming is now complete. The controller will return you to the normal operation mode.



6.4 Advanced programming

Info



Note

The controller is pre-programmed for use with a 10 x 35 tank.

Info



Note

Press and hold  +  for 5 seconds to access advance programming.

6.4.1 Advanced programming mode chart

Parameter description	Range of values	Default value	Units of measure	Notes
Chlorine generator	0 - 2	0	N/A	<ul style="list-style-type: none"> • 0: Disabled • 1: Salt Alarm Only Enabled 2: Chlorine Generator with Salt Alarm Enabled
Service interval	0 - 99	12	month	0: Disabled
Calendar override	0; 0.5; 1; 2; 3; ... ; 99	14	day	0: Disabled
Remote regeneration switch close time	1 - 254	30	second	-
Manual regeneration options	0 or 1	1	N/A	<ul style="list-style-type: none"> • 0: Immediate only • 1: Delayed / Immediate
Salt amount	0.1 - 50.0	3.7	kg	In steps of 0.1 kg.
Capacity	0.1 - 14.0	1.9	kg equivalent CaCO ₃	In steps of 0.1 kg.
Language	1 - 8	1	N/A	<ul style="list-style-type: none"> • 1: English • 2: Spanish • 3: French • 4: German • 5: Portuguese • 6: Dutch • 7: Russian • 8: Italian

Parameter description	Range of values	Default value	Units of measure	Notes
Reserve type	0 – 3	0	N/A	<ul style="list-style-type: none"> • 0: Variable • 1: Fixed • 2: Variable immediate • 3: Fixed immediate
Reserve percent	0 – 70	15	%	-
Clock mode	12 or 24	24	N/A	<ul style="list-style-type: none"> • 12: 12 hours (AM/PM) • 24: 24 hours
Units of measure	0 or 1	1	N/A	<ul style="list-style-type: none"> • 0: US • 1: Metric
Refill controller	0.14 or 0.33 or 0.77	0.33	gpm	Must be always set to 0.33.
Injector type	1B – 8B	5B	N/A	<ul style="list-style-type: none"> • 5B: For tanks until 10 x 54 • 8B: Above tanks 10 x 54
Slow rinse	1 – 125	61	minute	-
Backwash	1 – 50	3	minute	-
Fast rinse	1 – 30	3	minute	-

6.4.2 Chlorine generator

Set the salt alarm mode.

Options:

- 0: Disabled
- 1: Salt Alarm Only Enabled
- 2: Chlorine Generator with Salt Alarm Enabled

1. Press when chlorine generator is displayed.

⇒ The displayed number flashes.

2. Adjust option with and .







⇒ Default setting: 0 (disabled).

3. Press to validate the selection and advance to the next parameter using or .



6.4.3 Service interval







Set the salt alarm mode.

1. Press  when service interval is displayed.
⇒ The displayed number flashes.
2. Adjust service interval with  and .
- ⇒ Default setting: 12 months.
3. Press  to validate the selection and advance to the next parameter using  or .



6.4.4 Calendar override







Set the maximum number of days that the valve is in service without regenerating, regardless from the volume of water used.

1. Press  when calendar override is displayed.
⇒ The displayed number flashes.
2. Adjust calendar override with  and .
- ⇒ Default setting: 14 days.
3. Press  to validate the selection and advance to the next parameter using  or .



6.4.5 Remote regeneration switch close time

Set the switch closing time required to start a remote regeneration.

1. Press  when remote regeneration switch is displayed.
⇒ The time flashes.
2. Adjust switch closing time with  and .
- ⇒ Default setting: 30 seconds.
3. Press  to validate the selection and advance to the next parameter using  or .









6.4.6 Manual regeneration options

Set the manual regeneration mode.

Options:

- 0: Immediate only
- 1: Delayed / Immediate

1. Press  when manual regeneration is displayed.
⇒ The displayed number flashes.
2. Adjust option with  and .
- ⇒ Default setting: 1 (delayed/immediate).
3. Press  to validate the selection and advance to the next parameter using  or .



6.4.7 Salt amount

The salt amount used for regeneration is related to the tank size.

Tank size	Salt amount [kg]
7 x 35	1.9
8 x 35	2.5
9 x 35	3.2
10 x 35	3.7
10 x 44	4.4
10 x 54	5.7
12 x 48	6.3
12 x 52	7.5
13 x 44	8.2
13 x 54	9.4
14 x 65	12.5

Set the salt amount.

- Press when salt amount is displayed.
⇒ The salt amount flashes.
- Adjust salt amount with and .
- Press to validate the selection and advance to the next parameter using or .

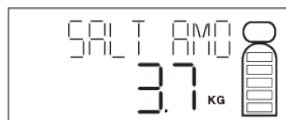

6.4.8 Capacity

The system capacity is related to the tank size.

Tank size	Capacity [kg equivalent CaCO ₃]
7 x 35	0.9
8 x 35	1.2
9 x 35	1.5
10 x 35	1.9
10 x 44	2.1
10 x 54	2.8
12 x 48	3.1
12 x 52	3.7
13 x 44	4.0
13 x 54	4.6
14 x 65	6.1

Set the system capacity.

1. Press **■** when capacity is displayed.
⇒ The system capacity flashes.
2. Adjust capacity with **▲** and **▼**.
⇒ Default setting: 1.9 kg equivalent CaCO₃.
3. Press **■** to validate the selection and advance to the next parameter using **▼** or **▲**.



6.4.9 Language

Set the displayed language.

Options:

- 1: English
- 2: Spanish
- 3: French
- 4: German
- 5: Portuguese
- 6: Dutch
- 7: Russian
- 8: Italian

1. Press **■** when language is displayed.
⇒ The displayed number flashes.
2. Adjust option with **▲** and **▼**.
⇒ Default setting: 1 (English).
3. Press **■** to validate the selection and advance to the next parameter using **▼** or **▲**.









6.4.10 Reserve type

Set the reserve type.

Options:







- 0: Variable
- 1: Fixed
- 2: Variable immediate
- 3: Fixed immediate

1. Press  when reserve type is displayed.
 - ⇒ The displayed number flashes.
2. Adjust option with  and .
- ⇒ Default setting: 0 (variable).
3. Press  to validate the selection and advance to the next parameter using  or .



6.4.11 Reserve percent

Set the reserve percentage.

1. Press  when reserve percent is displayed.
 - ⇒ The percentage flashes.
2. Adjust reserve percentage with  and .
- ⇒ Default setting: 15 %.
3. Press  to validate the selection and advance to the next parameter using  or .









6.4.12 Clock mode

Set the clock mode.

Options:

- 12: 12 hours (AM/PM)
- 24: 24 hours

1. Press  when clock mode is displayed.
 - ⇒ The displayed number flashes.
2. Adjust option with  and .
- ⇒ Default setting: 24 (24 hours).
3. Press  to validate the selection and advance to the next parameter using  or .



6.4.13 Units of measure

Set the system units of measure.

Options:

- 0: US
- 1: Metric

1. Press **■** when units of measure is displayed.
⇒ The displayed number flashes.
2. Adjust option with **▲** and **▼**.
⇒ Default setting: 1 (metric).
3. Press **■** to validate the selection and advance to the next parameter using **▼** or **▲**.



6.4.14 Refill controller

Mandatory



The refill controller must always be set to 0.33.

Set the system refill controller.

Options:

- 0.14
- 0.33
- 0.74

1. Press **■** when refill controller is displayed.
⇒ The displayed refill controller flashes.
2. Adjust option with **▲** and **▼**.
⇒ Default setting: 0.33.
3. Press **■** to validate the selection and advance to the next parameter using **▼** or **▲**.



6.4.15 Injector

Mandatory



The valve is delivered with an injector size 5B. This injector must be used with tanks until 10 x 54. For bigger tanks, the injector size 8B must be used.

See Injector cleaning [→Page 60].

Set the injector size.

1. Press **■** when injector is displayed.
⇒ The injector size flashes.
2. Adjust option with **▲** and **▼**.
⇒ Default setting: 5B.
3. Press **■** to validate the selection and advance to the next parameter using **▼** or **▲**.









6.4.16 Slow rinse

Slow rinse duration is related to the tank size.

Tank size	Fast rinse duration [min]
7 x 35	30
8 x 35	41
9 x 35	51
10 x 35	61
10 x 44	71
10 x 54	91
12 x 48	66
12 x 52	79
13 x 44	86
13 x 54	99
14 x 65	125

Set slow rinse duration.

- Press  when slow rinse is displayed.
⇒ The slow rinse duration flashes.
- Adjust slow rinse duration with  and .
- Press  to validate the selection and advance to the next parameter using  or .



6.4.17 Backwash

Backwash duration is related to the tank size.

Tank size	Fast rinse duration [min]
7 x 35	3
8 x 35	3
9 x 35	3
10 x 35	3
10 x 44	4
10 x 54	5
12 x 48	4
12 x 52	4
13 x 44	3
13 x 54	5
14 x 65	6

Set backwash duration.

1. Press **■** when backwash is displayed.
⇒ The backwash duration flashes.
2. Adjust backwash duration with **▲** and **▼**.
⇒ Default setting: 3 minutes.
3. Press **■** to validate the selection and advance to the next parameter using **▼** or **▲**.



6.4.18 Fast rinse

Fast rinse duration is related to the tank size.

Tank size	Fast rinse duration [min]
7 x 35	3
8 x 35	3
9 x 35	3
10 x 35	3
10 x 44	4
10 x 54	5
12 x 48	4
12 x 52	4
13 x 44	3
13 x 54	5
14 x 65	6

Set fast rinse duration.

1. Press **■** when fast rinse is displayed.
⇒ The fast rinse duration flashes.
2. Adjust fast rinse duration with **▲** and **▼**.
⇒ Default setting: 3 minutes.
3. Press **■** to validate the selection. Advanced programming is now complete. The controller will return you to the normal operation mode.



6.4.19 Historic

To access diagnostic values, press and hold **■** and **▼** for 5 seconds to access the historical information. Use **▲** and **▼** to navigate.

Scrolling Display Readout	Range/Values
MODEL NUMBER	1 - 99
DAYS SINCE REGENERATION	0 - 255 days
PEAK FLOW RATE - DAY AND TIME	Language/Clock Mode Dependant
PEAK FLOW RATE LPM*	0 - 177*

Scrolling Display Readout	Range/Values
WATER TREATED TODAY LITER	0 – 6'553.6
WATER SINCE REGENERATION LITER	0 – 6'553.6
SUNDAY AVERAGE USAGE METER	0 – 6'553.6
MONDAY AVERAGE USAGE METER	0 – 6'553.6
TUESDAY AVERAGE USAGE METER	0 – 6'553.6
WEDNESDAY AVERAGE USAGE METER	0 – 6'553.6
THURSDAY AVERAGE USAGE METER	0 – 6'553.6
FRIDAY AVERAGE USAGE METER	0 – 6'553.6
SATURDAY AVERAGE USAGE METER	0 – 6'553.6
TOTAL WATER USED LITER X 100*	0 – 99'990*
TOTAL WATER USED LITER X 1000000*	0 – 4'294'000*
MONTHS SINCE SERVICE*	0 to 2184 months*

* Bold text indicates that specific values can be reset. Press and hold  for 5 seconds to reset the value.

6.4.20 Resetting the controller



Info



Resetting the controller will delete all information stored in its memory, except the time and day.

This will require you to reprogram the controller completely from the initial power-up mode.

Resetting the controller:

1. Press and hold the  and  until the display blanks out.
 - ⇒ When realising the buttons, model number displays.
2. To reset the controller, press and hold  for 5 seconds.
 - ⇒ The controller will be reset to an unprogrammed state.
3. Go to Programming [[→Page 36](#)], to reprogram the controller.

7 Commissioning

Info



This chapter is available for standard regeneration flows. Contact your supplier if the actual regeneration is not standard and if you need assistance.

7.1 Water filling, draining and waterproofness inspection

7.1.1 Activating the softener

After you have performed the previous initial programming steps, you will need to activate the softener.





Caution - material



Do not rotate the camshaft by hand or damage to the unit may occur.

Use the controller to take the camshaft electronically through the cycles.

Follow these steps carefully:

1. Remove the cover from the valve. Removing the cover will allow you to see that the camshaft is turning, and in which cycle the camshaft is currently positioned.
2. With the supply water for the system still turned off, position the bypass valve to the "non-bypass" (normal operation) position.
3. Press  on the controller for 5 seconds. This will initiate a manual regeneration. The controller will indicate that the motor is turning the camshaft to cycle C1 (Brine refill)
4. Press  and  to pass to the next cycle. Keep pressing until cycle C5 (Backwash). The controller will display the total regen time remaining. If you press and hold the  button, the controller will indicate the time remaining in the current cycle.
5. Fill the media tank with water.
 - ⇒ While the controller is in cycle C5 (Backwash), disconnect the power supply and open the water supply valve very slowly to approximately the ¼ open position.

Info







If opened too rapidly or too far, media may be lost out of the tank into the valve or the plumbing. In the ¼ open position, you should hear air slowly escaping from the valve drain line.

- ⇒ When all of the air has been purged from the media tank (water begins to flow steadily from the drain line), open the main supply valve all of the way. This will purge the final air from the tank.
 - ⇒ Allow water to drain out until the water runs clear from the drain line. This purges any refuse from the media bed.
 - ⇒ Turn off the water supply and let the system stand for about 5 minutes. This will allow any trapped air to escape from the tank.
6. Add water to the brine tank (initial fill).

- ⇒ With a bucket or hose, add approximately 15 liters of water to the brine tank.
If the tank has a salt platform in the bottom of the tank, add water until the water level is approximately 25 mm (1") above the platform.





Info

Pentair recommends that recommend that you do not put salt into the tank before the control valve has been started up. With no salt in the tank, it is much easier to view water flow and motion.

7. Connect power supply.
8. Slowly open the main water supply valve again, to the fully open position. Be sure not to open too rapidly as that would push the media out of the media tank.
9. Press  and  to pass to the Fast rinse (C6) position.
 - ⇒ Stay in this position for a couple of minutes.
10. Press  and  to pass to Service.
11. Press and hold  for 5 seconds to initiate immediate manual regeneration.
 - ⇒ Stay in this position for a couple of minutes.

Info

As you advance through each cycle there will be a slight delay before you can advance to the next cycle. There may be a pause at cycle C4 (System Pause). This cycle allows the water/air pressure to equalize on each side of the valve discs before moving on. The hourglass will not be visible indicating that the system is paused.

12. Press  and  to pass to the next cycle.
 - ⇒ Stay in this position for a couple of minutes.
13. Repeat the previous point for each regeneration cycle.
 - ⇒ In Brine/Slow rinse cycle (C3), verify that the brine level decrease in the brine tank. If this is not the case, the suction line has a malfunction.
14. If the water level is receding from the brine tank you can then advance the controller back to the treated water C0 position by pressing  and  simultaneously to advance the controller to the C0 position.
15. Finally, turn on a faucet plumbed after the water softener. Run the faucet until the water runs clear. Add salt to the brine tank.

7.1.2 Additional tips

- When the controller is first plugged in, it may display a flashing hourglass and the message "Err 3", this means that the controller is rotating to the home position;
- the preset default time of regeneration is 2:00 AM;
- power supply: The World controller senses the electrical input and decides which is needed;
- if electrical power is not available, the camshaft can be rotated counter-clockwise by hand if the motor is removed;
- the controller sends commands to the motor for camshaft movement. However, water pressure/flow are required during the regeneration cycle for backwash, purge and refill, and brine draw to actually take place;

- make sure the control power source is plugged in. The transformer should be connected to a non-switched power source;
- you can start programming from the beginning by resetting the amount of media, see Resetting the controller [→Page 50].

7.2 Sanitization

7.2.1 Disinfection of water softeners

The materials of construction of the modern water softener will not support bacterial growth, nor will these materials contaminate a water supply. In addition, during normal use, a softener may become polluted with organic matter, or in some cases with bacteria from the water supply. This may result in an off-taste or odour in the water.

Thus, the softener may need to be disinfected after installation. Some softeners will require periodic disinfection during their normal lifetime. Consult the installing dealer for more information on softener disinfection.

Depending on the conditions of use, the softener type, the type of ion exchanger and the disinfectant available, a choice can be made among the following methods.

7.2.2 Sodium or calcium hypochlorite

These materials are satisfactory for use with polystyrene resins, synthetic gel zeolite, greensand and bentonites.

5.25% Sodium hypochlorite

If stronger solutions are used, such as those sold for commercial laundries, adjust the dosage accordingly.

Dosage

Polystyrene resin: set 1.25 mL fluid per 1 L of resin.

Non-resinous exchangers: set 0.85 mL fluid per 1 L.

Brine tank softeners

Backwash the softener and add the required amount of hypochlorite solution to the well of the brine tank. The brine tank should have water in it to permit the solution to be carried into the softener.

Proceed with the normal regeneration.

Calcium hypochlorite

Calcium hypochlorite, 70% available chlorine, is available in several forms including tablets and granules. These solid materials may be used directly without dissolving before use.

Do not let the disinfectant stand for more than 3 hours in the brine tank before the regeneration start.

Dosage

Measure two grains ~ 0.11 mL for 1 L.

Brine tank softeners

Backwash the softener and add the required amount of hypochlorite to the well of the brine tank. The brine tank should have water in it to permit the chlorine solution to be carried into the softener.

Proceed with the normal regeneration.

7.2.3 Electro chlorination (if present)

Valves or systems already equipped with an electrochlorinator device or system will be sanitized during the brine draw phase.

8 Operation

During a regeneration:

- A "C#" is displayed to show the current cycle;
- total regen time remaining is displayed on screen;
- you can press and hold  to show current cycle time remaining.

8.1 Recommendations

- Use only regeneration salts designed for water softening EN973;
- for optimal system operation, the use of clean salt and impurities free is recommended (for example salt pellets);
- do not use ice melt salt, block, or rock salts;
- the sanitizing process (both with liquid and electrochlorination) may introduce chlorine compounds which may reduce the life of the ion exchange resins. Refer to media manufacturer specifications sheet for more information.

8.2 Manual regeneration

Mandatory



The controller must be in service in order to enable this procedure.

Info



Note

The unit returns to normal operation if no buttons are pressed within 30 seconds.

Manual delayed regeneration

1. Press  once to program a delayed regeneration.
 - ⇒ The regeneration will start on the scheduled time. See Basic programming [→Page 38].

Info







Note

To cancel: press  again.

Immediate regeneration

1. Press and hold  for 5 seconds to initiate immediate manual regeneration.
 - ⇒ Camshaft starts rotating to cycle C1.

8.3 To advance regeneration cycles

1. Simultaneously press  and  to advance to the next cycle.
 - ⇒ When the camshaft reaches next cycle, "C2" will be displayed.
2. Repeat  and  to advance through each cycle.

8.4 To cancel a regeneration

1. Press and hold  and  for 5 seconds to cancel the regen.

⇒ Camshaft will move to service position – may take 1 to 2 minutes.

9 Maintenance

Mandatory



Cleaning, maintenance and service operation shall take place at regular intervals and must be done by qualified personnel only in order to guarantee the proper functioning of the complete system.

Report maintenance done in the Maintenance chapter of the User Guide document.

Failure in respecting above instructions may void the warranty!

9.1 General system inspection

Mandatory



Has to be done once a year at minimum.

9.1.1 Water quality

1. Raw water total hardness.
2. Treated water hardness.

9.1.2 Mechanical Checks

1. Inspect general condition of valve and associated ancillaries and check for any leaks, ensure valve connection to piping is made with adequate flexibility as per manufacturer instruction.
2. Inspection of electrical connections, verify wiring connections and search for evidence of overloading.
3. Verify settings of electronic timer, verify regeneration frequency, make sure the valve configuration correspond to the settings.
4. Check water meter, if present, report water meter settings and compare with previous inspection.
5. Verify total water consumption compared to previous visit.
6. If pressure gauges are installed before and after softening system, verify and record static and dynamic pressure, reporting pressure drop. Verify that inlet pressure respects valve and softening system limits.
7. If pressure gauges are not present, but suitable points exist, install temporary pressure gauge(s) to perform precedent point.

9.1.3 Regeneration test

1. Check condition of brine tank and any associated equipment.
2. Check salt level in brine tank.
3. Initiate regeneration test.
 - ⇒ Check for brine draw off levels.
 - ⇒ Check for resin loss at the drain during regeneration.

⇒ Where fitted, check for satisfactory operation of solenoid, i.e. outlet shut off during regeneration and/or brine line shut off valve(s).

4. Test and record Total Hardness of outlet water from softener vessel(s).

9.2 Recommended maintenance plan

Items	1 year	2 year	3 year	4 year	5 year
Injector & filter	Clean	Clean	Clean	Clean	Clean/ replace if necessary
Refill controller**	Clean	Clean	Clean	Clean	Clean/ replace if necessary
DLFC**	Clean	Clean	Clean	Clean	Clean/ replace if necessary
1265 Bypass (if present, contains O-rings**)	-	-	-	-	Clean/ replace if necessary
Flappers	-	-	-	-	Replace
Flappers spring	-	-	-	-	Replace
O-Rings**	Check for watertightness / clean or replace in case of leakage	Check for watertightness / clean or replace in case of leakage	Check for watertightness / clean or replace in case of leakage	Check for watertightness / clean or replace in case of leakage	Check for watertightness / clean or replace in case of leakage
Motor, motor cable and optical sensor harness	Check	Check	Check	Check	Replace
Optical sensor	Check	Check	Check	Check	Replace
Inlet Hardness	Check	Check	Check	Check	Check
Residual hardness	Check / adapt mixing screw if necessary	Check / adapt mixing screw if necessary	Check / adapt mixing screw if necessary	Check / adapt mixing screw if necessary	Check / adapt mixing screw if necessary
Electronic / settings*	Check	Check	Check	Check	Check / replace if necessary
Transformer*	Check	Check	Check	Check	Check / replace if necessary
Chlorine generator (if present)	Check / clean	Check / clean	Check / clean	Check / clean	Check / clean / replace if necessary

Items	1 year	2 year	3 year	4 year	5 year
Turbine (if present, internal or external model)**	Check / clean	Check / clean	Check / clean	Check / clean	Replace
Turbine cable (if turbine present)	Check	Check	Check	Check	Replace
Valve watertightness	Check	Check	Check	Check	Check
Valve to piping watertightness	Check	Check	Check	Check	Check

* Electronical parts – durability strongly affected by power source quality and stability

** Elastomer durability is strongly affected by raw water concentration in chlorine and its derivate

*** Wear part.

9.3 Recommendations

9.3.1 Use original spare parts

Caution - material



Risk of damage due to use of non-genuine spare parts !

To ensure correct operation and safety of the device, only use original spare parts and accessories recommended by the manufacturer.

Usage of non-genuine spare parts voids all warranties.

Parts to keep in stock for potential replacements are motor and optical sensor, controller, transformer, injectors, flapper kit, O-ring kit, refill flow controller and DLFC.

9.3.2 Use original approved lubricants

- Production:
p/n 1014082 (NFO "Chemplex" 862 Silicone Comp.);
- spare part:
p/n 42561 (SILICONE LUBRICANT PACK).

9.3.3 Maintenance instructions

- Disinfect and clean the system at least once a year or if the treated water has an off-taste or an unusual odor;
- perform a hardness test every year of both inlet and treated water.

9.4 Cleaning and maintenance

9.4.1 First steps

Before any cleaning or maintenance procedure, complete the following steps:

Mandatory



These operations must be performed before any cleaning or maintenance procedure !

1. Unplug the wall-mounted transformer.
2. Shut off water supply or put bypass valve(s) into bypass position.
3. Relieve system pressure before performing any operations.

9.4.2 Injector cleaning

1. Using a Torx key, unscrew and remove the injector cap (4).

Caution - material



Take care not to damage the injector (5).

2. Using pliers, gently extract the injector (5) from valve body.
3. Clean the injector (5) using compressed air, a soft brush or possibly a pin.
4. Reverse above procedure steps to rebuild.

9.4.3 Refill controller cleaning

1. Using a Torx key, unscrew and extract the refill controller (3).
2. Clean the refill controller (3) with a soft brush.
⇒ Make sure the refill controller groove is perfectly clean.
3. Check for O-rings integrity.
4. Check for ball (2) integrity (if present).
5. Clean the refill controller chamber (1) before reinserting the refill controller (3).
6. Reverse above procedure steps to rebuild.

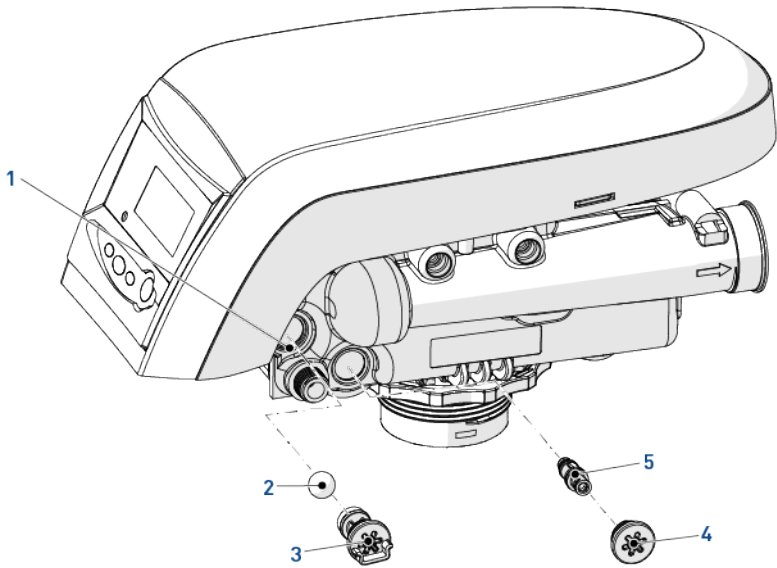

9.4.4 Injector screen cleaning

1. Using a Torx key, unscrew and extract the injector screen cap (4).
2. Unclip the white plastic basket (5) and clean it with a soft brush.
 - ⇒ Use of descaling agent such as white vinegar might be required in case of impurities on the plastic basket (5).
3. Check for O-rings integrity before reinserting the injector screen cap (4).
4. Reverse above procedure steps to rebuild.

9.4.5 Backwash controller cleaning

1. Using a Torx key, unscrew and extract the backwash flow controller (3).
2. Clean the backwash controller (3) using a soft brush or compressed air.
3. Check for O-rings integrity before reinserting the backwash controller (3).

Info



Note

Depending on the backwash controller size, it may be of a different type to that shown below. If the model fitting the valve is with the ball (2), make sure to clean the backwash controller grooves and backwash controller chamber (1). Also check for ball (2) integrity before reinserting.

4. Reverse above procedure steps to rebuild.

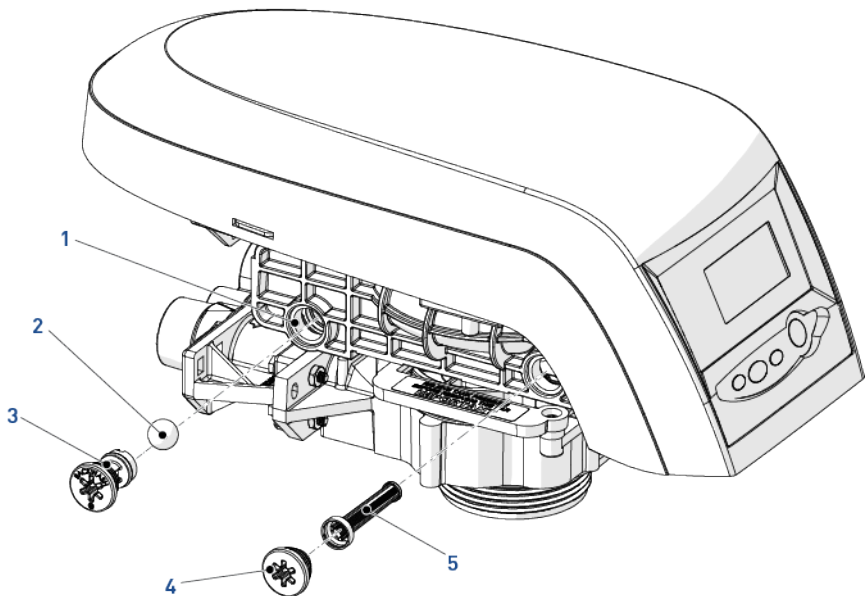

9.4.6 Valve cover disassembly

1. Unlock the cover **[1]** from the slide clips **[2]** (one on each side of the valve).
2. Lift the cover **[1]**.
3. Reverse above procedure steps to rebuild.

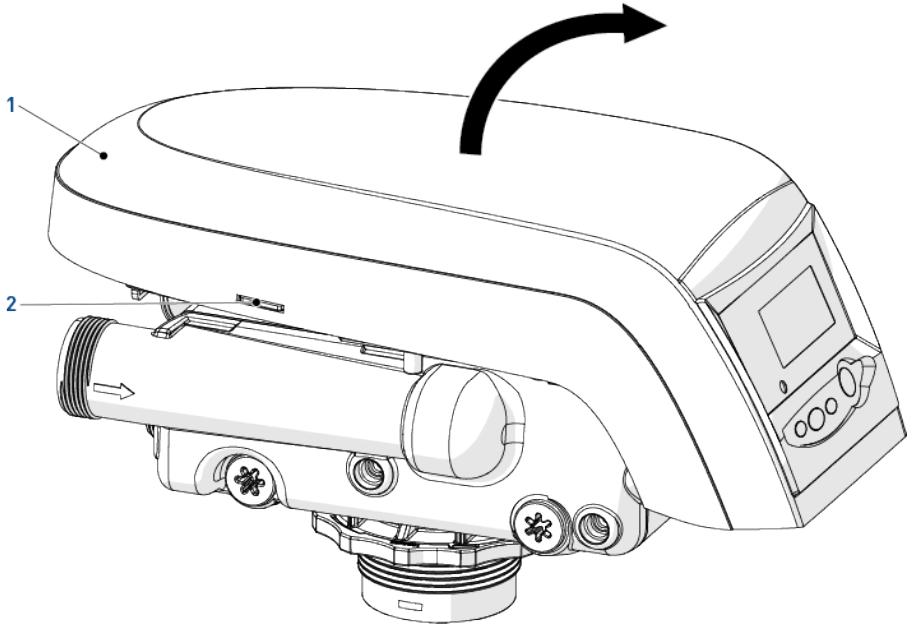

9.4.7 Motor and camshaft replacement

1. Remove the white locking pin (2) securing the motor (3).
2. Turn the motor (3) counter clockwise and slide it out of its position.
3. Slide the camshaft (1) backwards until it is released from its mounting boss, then lift it up.

Info



Note

To replace the motor, you also have to disconnect the optical sensor cable. See Optical sensor and controller replacement [→Page 65].

4. Reverse above procedure steps to rebuild.

Caution - material



When reassembling the camshaft (1), place it in the centering hole and use the arrows on the top plate and the camshaft to align the camshaft.

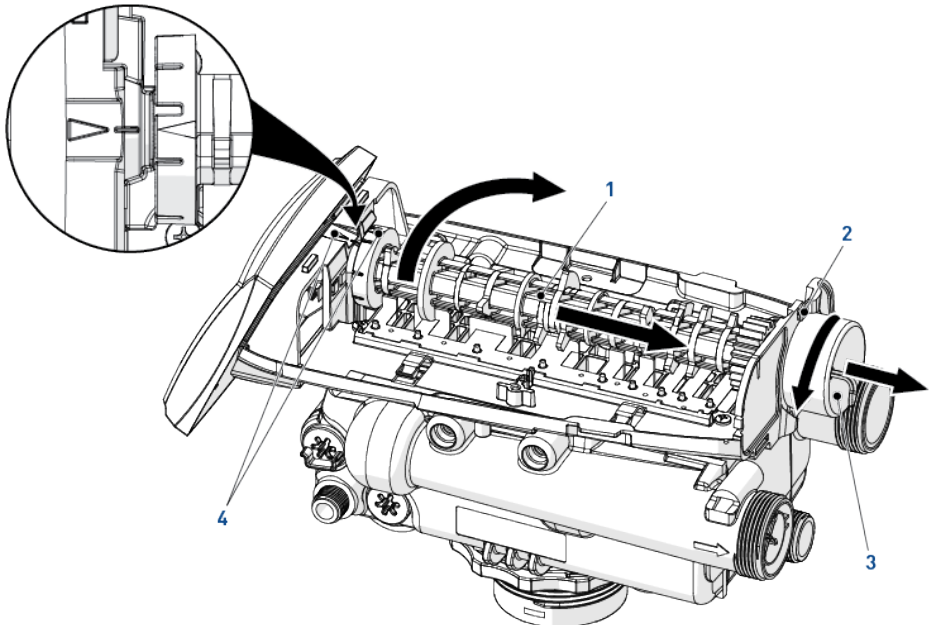

9.4.8 Optical sensor and controller replacement

Info



Note

To remove the optical sensor, you first have to disassemble the camshaft. See Motor and camshaft replacement [→Page 64].

1. The optical sensor (2) is clipped on the front edge, gently press on the clips to release the optical sensor (2) from its location.
2. Press the controller locking pad (4) and slide the controller (3) out of its position.
3. Disconnect the cables from the controller by pressing on the clip and pulling them.
4. Remove the motor, cables and optical sensor assembly to change them.
5. Reverse above procedure steps to rebuild.

Caution - material



When refitting, always use the cables guide (1) to secure the cables. This will prevent the cables from being crushed or cut when closing the cover or by the camshaft during regeneration cycles.

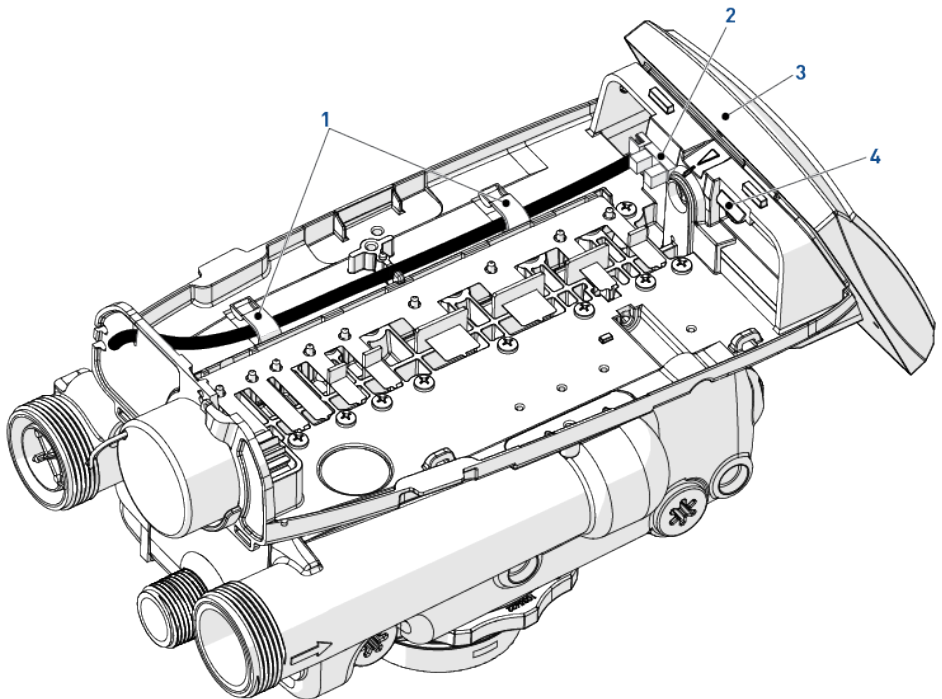

9.4.9 Turbine cleaning or replacement

Info



Note

Depending on the valve installation, the turbine may not be present (optional equipment).

1. Remove the turbine cable (2) by pushing it up and pulling it from the other side.
2. Remove the turbine cable (2) from the cable guide (1).
3. Using pliers, gently extract the turbine (3) from the outlet pipe (4) of the valve.
4. Clean the turbine (3) using a soft cloth and a brush.
5. Reverse above procedure steps to rebuild.

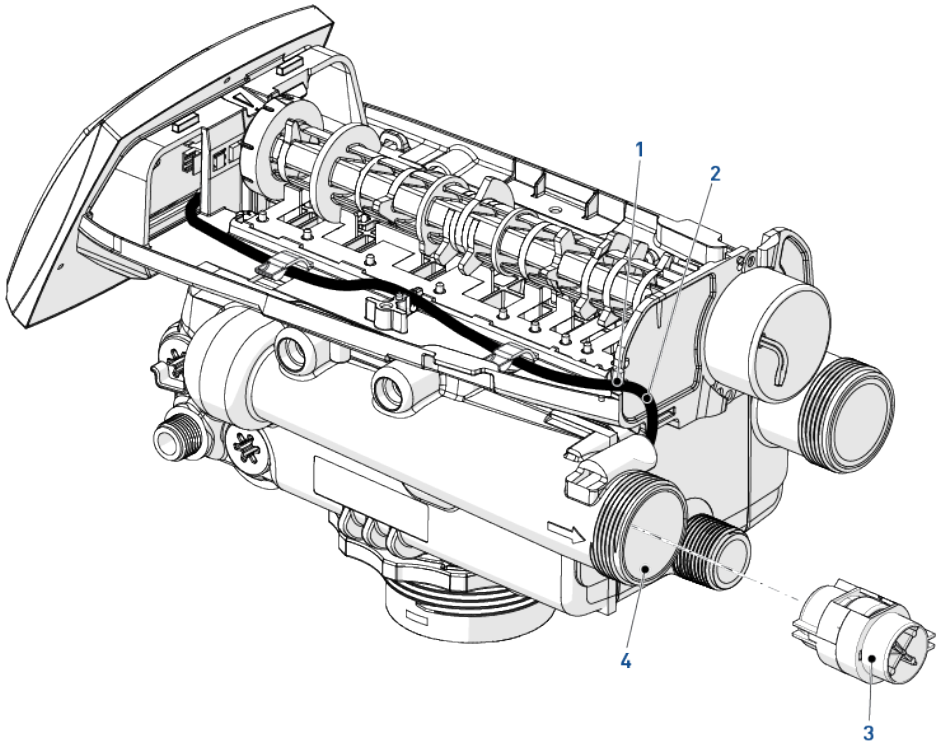

9.4.10 Top plate, flapper spring and flappers replacement

WARNING



Take care with sharp edges.

Use of protective glove is highly recommended to remove the spring (4).

1. Using a flat screwdriver, release the flapper springs (2) one by one and then remove the spring (3).
2. Loosen all top plate screws (1).
3. Remove the top plate (4) from the valve.
4. Clean or replace the flappers (5) if needed.

Caution - material



The outline of the flapper seat can be seen on the flapper side.

If the outline is irregular, this may indicate that debris is or has been preventing the flapper (1) from closing, and potential damage.

5. Reverse above procedure steps to rebuild.

Caution - material



When refitting the top plate (4), always follow the screwing order below.

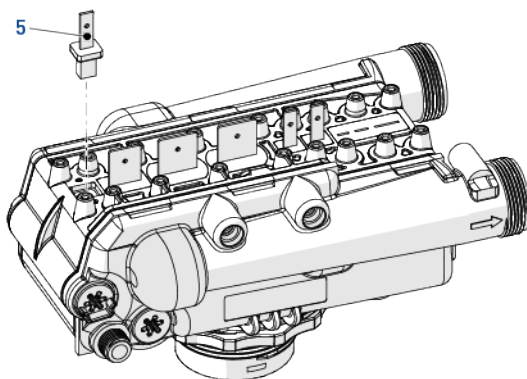
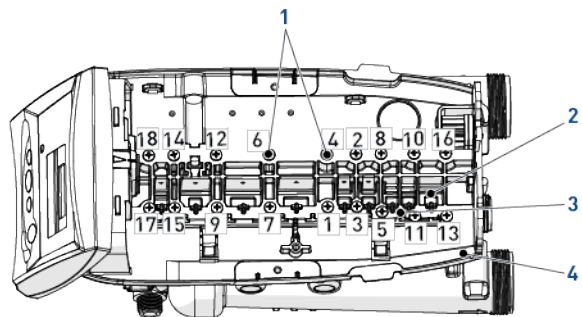

9.4.11 Valve on tank assembly

1. Lubricate the seals with approved silicone grease.
2. Spin the valve (1) onto the tank (2), ensuring the threads are not cross-threaded.
3. Rotate the valve (1) clockwise and freely, without using force until it comes to a stop.

Info



This stop position is considered point zero.

4. Rotate the valve (1) clockwise from point zero to between 1/4 turn and 1/2 turn.

Caution - material



Risk of damage due to excessive force !

Do NOT exceed 27 Nm of torque when installing the valve. Exceeding this limit may damage the threads and cause failure.

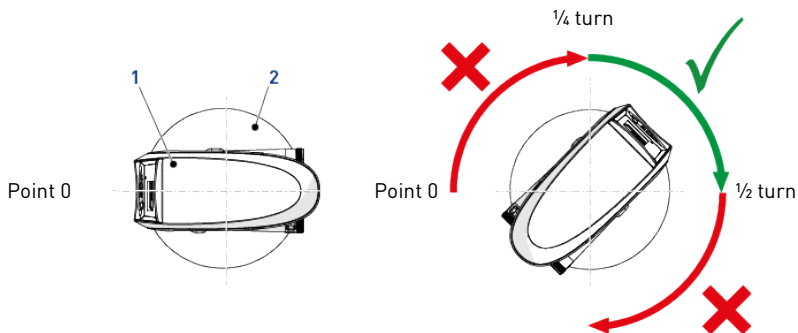

10 Troubleshooting

10.1 Logix controller

Err. code	Cause	Solution
ERR 1	Controller power has been connected and the controller is not sure of the operating status.	Reset controller. See Resetting the controller [→Page 50].
ERR3	Controller lost the position of camshaft. Camshaft should be rotating to find Home position.	Wait for 2 minutes: the controller returns to Home position. An hourglass icon flashes to indicate that the motor is running.
	Camshaft does not rotate.	Check: <ul style="list-style-type: none"> • Motor connections. • If motor wire harness is connected to the motor. • If motor wire harness is connected to the controller. • Optical sensor connection and position. • If motor and camshaft gears are engaged.
	Camshaft rotates for more than 5 minutes to find Home position.	If everything is connected, try replacing in this order: <ul style="list-style-type: none"> • Wire harness. • Motor. • Optical sensor. • Controller. • See Cleaning and maintenance [→Page 60].
	Camshaft rotates for more than 5 minutes to find Home position.	Check: <ul style="list-style-type: none"> • Optical sensor connection and position. • Camshaft connection. • Camshaft slots cleanness.

Err. code	Cause	Solution
ERR3	Camshaft rotates for more than 5 minutes to find Home position.	<p>If motor keeps rotating indefinitely, replace the following components in this order:</p> <ul style="list-style-type: none"> • Wire harness. • Motor. • Optical sensor. • Controller. • See Cleaning and maintenance [→Page 60].

10.2 Performa Valve

Issue	Cause	Solution
- - : - -	Power failure occurred.	Press  to reset the time.
Brine tank overflow.	Uncontrolled brine refill flow rate.	Remove brine controller to clean ball and seat.
	Air leak in brine line to air check.	Check all connections in brine line for any leaks.
	Drain control clogged with resin or other debris.	Clean drain control.
Flowing or dripping water at drain or brine line after regeneration.	Valve stem return spring is weak.	Replace the spring.
	Valve disc cannot close because of debris.	Remove debris.
Hard water leakage after regeneration.	Improper regeneration.	Control brine dosage setting and repeat regeneration.
	Leaking of external bypass valve.	Replace bypass valve.
	O-ring around riser pipe damaged.	Replace O-ring.
	Incorrect capacity.	Verify appropriate brine amount and system capacity.

Issue	Cause	Solution
Controller will not draw brine.	Low water pressure.	Control and adjust setting according to instructions.
	Restricted drain line.	Remove restriction.
	Injector plugged.	Clean injector and screen.
	Injector defective.	Replace injector and cap.
	Valve disc 3 not closed.	Remove foreign matter from the disc. Check if the disc can close by pushing on stem. Replace the disc if needed.
Controller will not regenerate automatically.	AC transformer or motor are not connected.	Connect the power.
	Defective motor.	Replace motor.
Controller regenerates at wrong time of day.	Controller set incorrectly.	Correct time setting according to instructions. See Regeneration time [→Page 40].
Valve will not draw brine.	Low water pressure.	Set pump to maintain 1.4 bar at softener.
	Restricted drain line.	Change drain to remove restriction.
	Injector plugged.	Clean injector and screen.
	Injector defective.	Replace injector.
System using more or less salt than brine setting.	Foreign matter in valve causing incorrect flow rates.	Remove brine controller and flush out foreign matter. Then advance controller to brine cycle (C2) to clean valve (after so doing controller goes to "2nd fast rinse" cycle (C7) to remove any brine from tank).
Intermittent or irregular brine draw.	Low water pressure.	Set pump to maintain 1.4 bar at softener.
	Defective injector.	Replace injector.
No conditioned water after regeneration.	No brine in brine tank.	Add brine to brine tank.
	Injector plugged.	Clean injector and screen.
	Air check valve closes prematurely.	Put controller momentarily into brine cycle (C2). Replace or repair air check if needed.
Backwashes or purges at excessively low or high rate.	Incorrect drain control used.	Replace with correct size controller.
	Foreign matter affecting valve operation.	Remove drain control and clean ball and seat.

Issue	Cause	Solution
No water flow display when water is flowing on 760 controller.	Bypass valve in bypass.	Shift bypass valve to non-bypass position.
	Meter probe disconnected or not fully connected to meter housing.	Fully insert probe into meter housing.
	Restricted meter turbine rotation due to foreign matter in meter.	Remove meter housing, free up turbine and flush with clean water. Turbine should spin freely. If not, replace meter.
Run out of conditioned water between regenerations.	Improper regeneration.	Control brine dosage set and repeat regeneration.
	Incorrect hardness, salt amount or capacity settings.	Set to correct values. See Basic programming [→Page 38] and Advanced programming [→Page 41].
	Water hardness has increased.	Set hardness to new value. See Hardness [→Page 40].
	Restricted meter turbine rotation due to foreign matter in meter.	Remove meter housing, free up turbine and flush with clean water. Turbine should spin freely. If not, replace meter.
Brine tank overflow.	Brine valve disc 1 being held open by foreign matter.	Manually operate valve stem to flush away obstruction.
	Valve disc 2 not closed during brine draw causing brine refill.	Flush out foreign matter holding disc open by manually operating valve stem.
	Air leak in brine line to air check.	Check all connections in brine line for any leaks.
	Improper drain control for injector.	Use of small drain control with larger injector will reduce draw rates.
	Drain control clogged with resin or other debris.	Clean drain control.

11 Spare parts

11.1 Valve parts list

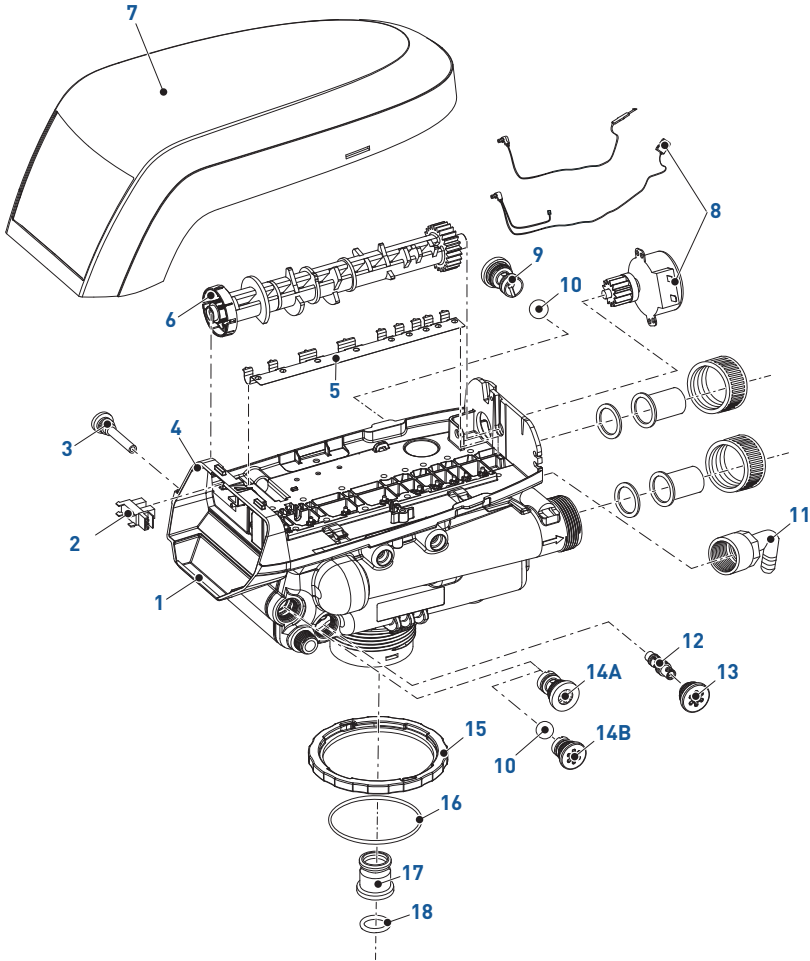

Item	Part number	Description	Assembly quantity
1	1255104	Valve assy with out flow controllers	1
2	1235373	Module, sensor, photo interrupter	1
3	1000226	Screen/cap assy with o-ring	1
4	1235338	Top Plate, AvantaPure Valves	1
5	1235339	Valve Disc Spring, One Piece, Performa Valve	1
6	1237402	Cam, AvantaPure Valve, STD, Green	1

Item	Part number	Description	Assembly quantity
7	1242282	Cover, Valve, AvantaPure Controller	1
8	1235361	Motor/Optical Cable Assembly	1
*	1233187	Motor Locking Pin	1
9	1000209	Drain controller assy No. 7 (1.2 gpm; 4.5 lpm)	1
*	1000210	Drain controller assy No. 8 (1.6 gpm; 6.1 lpm)	1
*	1000211	Drain controller assy No. 9 (2.0 gpm; 7.6 lpm)	1
*	1000212	Drain controller assy No. 10 (2.5 gpm; 9.5 lpm)	1
*	1000213	Drain controller assy No. 12 (3.5 gpm; 13.2 lpm)	1
*	1000214	Drain controller assy No. 13 (4.1 gpm; 15.5 lpm), no ball	1
*	1000215	Drain controller assy No. 14 (4.8 gpm; 18.2 lpm), no ball	1
*	1030355	External DLFC, 5 gpm (19 lpm)	1
*	1030356	External DLFC, 6 gpm (22.5 lpm)	1
*	1030357	External DLFC, 7 gpm (26.5 lpm)	1
*	1030358	External DLFC, 8 gpm (30 lpm)	1
*	1030359	External DLFC, 9 gpm (34 lpm)	1
*	1030360	External DLFC, 10 gpm (38 lpm)	1
*	1000406	External DLFC, 12 gpm (45 lpm)	1
*	1000407	External DLFC, 15 gpm (56.8 lpm)	1
*	1000409	External DLFC, 20 gpm (75.7 lpm)	1
*	1000269	Plug for backwash flow controller when used with external DLFC	1
10	1030502	Ball, internal DLFC up to nb 12 Included	2
11	1002449	Drain fitting elbow (3/4" hose barbed)	1
12	1032982	Injector 5 bumps	1
*	1032983	Injector 8 bumps	1
13	1000269	Injector cap with o-ring	1
14A	1000222	Regenerant refill controller, 33 GPM no ball	1
14B	1243510	Regenerant refill controller	1
15	1035622	Tank ring	1
16	1010154	Tank o-ring	1
*	1239760	Blending valve kit	1
*	1033444	Turbine assy	1
*	1041174	Standard/Sev valve disc kit	1
*	1239979	Cable harness for remote regeneration on 740F	1
17	1001986	13/16" rubber insert (optional)	1
*	1235446	Turbine cable, Logix, short	1

Item	Part number	Description	Assembly quantity
*	1239711	Switch kit, front mount, 0.1 Amp	1
*	1239752	Switch kit, front mount, 5 Amp	1
*	1239753	Switch kit, top plate mount, 0.1 Amp	1
*	1239754	Switch kit, top plate mount, 5 Amp	1
18	1232370	O-ring EP	1

* Not shown

11.2 869 Controller

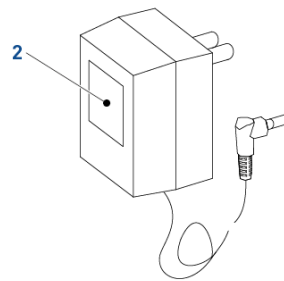
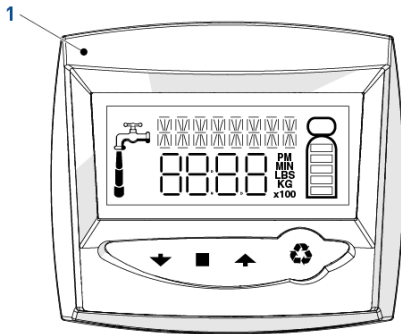

Item	Part number	Description	Assembly quantity
1	4003901	869 controller for 269 from 8" to 14"	1
2	1000813	Transformer British plug	1
*	1000814	Transformer European plug	1
*	1030234	Transformer extension cord 4.5 m	1

* Not shown

11.3 1265 Bypass & Connections

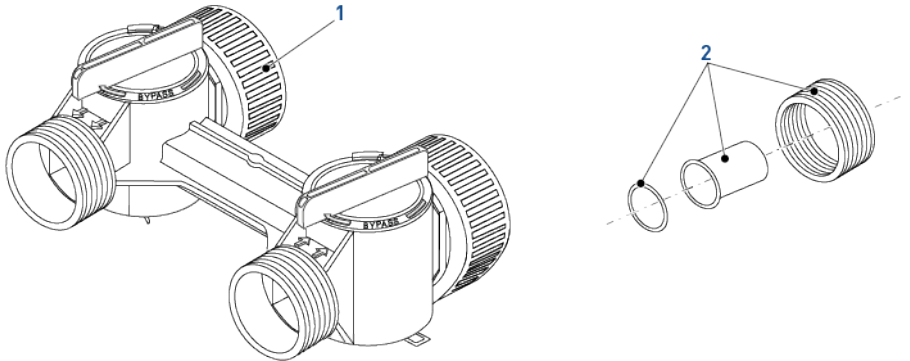

Item	Part number	Description	Assembly quantity
1	1040930	Bypass 1265	1
*	1034302	Repair kit (rotor seals & clips)	1
*	1030541	Gasket for 1" pipe or tube	2
*	1034385	Adapter nut 1 - 1 1/4" bakelite	2
2	3023824	3/4" BSPT stainless steel pipe adapter kit	2
*	3023807	1" BSPT stainless steel pipe adapter kit	2
*	1001608	22 mm copper tube adapter kit	2
*	1001615	32 mm PVC tube adapter kit	2
*	1001614	1" PVC tube adapter kit	2
*	1001613	3/4" PVC tube adapter kit	2

* Not shown

11.4 Valve installation kits

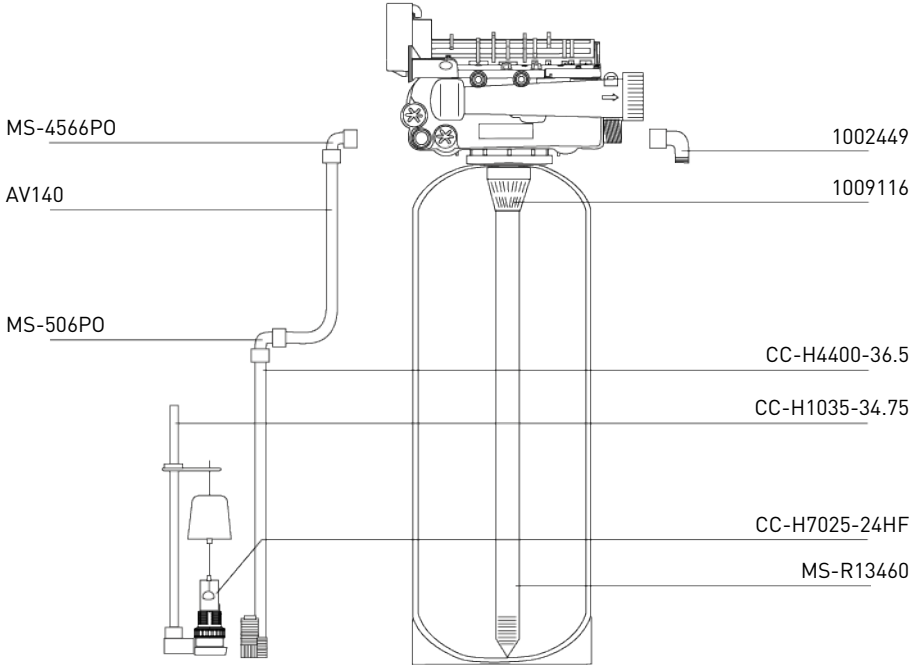

Item	Part number	Description	Assembly quantity
Kit-268	3029817	Kit - 268 consist of : 1002449, CC-D1203, MS-4566PO, CC-H4400-36.5, MS-R13460	1
*	1002449	Drain fitting elbow (3/4" hose barbed)	1
*	1009116	Upper screen	1
MS-R13460	3028263	Riser tube 1.050"	1
*	E01100	Fitting female elbow 3/8" Fx 3/8" tube	1
CC-H4400-36.5	3028255	Air check tube 3/8"	1
CC-H1035-34.75	1037194	Brine tube, 3/8" x 34.75"	1
CC-H7025-24HF	1036840	Brine valve, 3/8"	1

Item	Part number	Description	Assembly quantity
MS-50 6PO	E01140	Union elbow $\frac{3}{8}$ "T - $\frac{3}{8}$ "T	1
AV140	E01480	Tubing $\frac{3}{8}$ " Roll of 30 m	1

* Not shown

12 Disposal

The device must be scrapped in accordance with directive 2012/19/EU or the environmental standards in force in the country of installation. The components included in the system must be separated and recycled in a waste recycling center that conforms with the legislation in force in the country of installation. This will help to reduce the impact on the environment, health, safety and help to promote recycling. Pentair does not collect used product for recycling. Contact your local recycling center for more information.



Notes

www.pentair.eu